



L'APEI de Saint-Amand-Montrond,  
**un état d'esprit**

# Ouvrir l'emploi

—aux personnes en situation—  
de handicap



 **Le Verdier**  
43 salariés handicapés  
Agréée et contrôlée  
par la DIRECCTE

 **L'Artisanerie**  
79 salariés handicapés  
Agréée et contrôlée  
par la DIRECCTE

 **Foyers**  
Bernard-FAGOT  
5 foyers  
106 résidents  
Financés par le département

 **Vernet**  
INDUSTRIES  
2 ESAT  
107 usagers  
Financés par l'ARS

**87 000**  
partenaires privés et  
publics. Seuls soutiens  
des EA



**Association de Parents d'Enfants Inadaptés**  
RÉGIE PAR LA LOI DE 1901



# Nos Établissements de travail

## 46 ans

d'action auprès d'adultes en situation de handicap  
Insertion Professionnelle et Sociale & Loisirs



SIÈGE SOCIAL - ST-AMAND-MONTROND



ESAT VERNET INDUSTRIEL - 3 000 M<sup>2</sup>

L'association de parents d'enfants inadaptés de Saint-Amand-Montrond est une association à but non lucratif créée le 25 avril 1978 par un groupe de parents dans le département du Cher.

Gérée par un conseil d'administration composé de parents ou d'amis d'enfants inadaptés ou handicapés, cette association accueille principalement des adultes déficients intellectuels et/ou souffrant d'une altération du comportement adaptatif.

À ce jour, l'APEI gère 3 établissements de travail (ESAT et Entreprises adaptées), 5 foyers d'hébergement et une section adaptée.



E.A. L'ARTISANERIE - 10 300 M<sup>2</sup>



E.A. LE VERDIER - 4 000 M<sup>2</sup>



[www.apei.asso.fr](http://www.apei.asso.fr)

# Nos Foyers



L'ensemble des foyers créés et gérés par l'APEI de Saint-Amand-Montrond porte le nom de « Foyers Bernard-Fagot ». Monsieur Bernard Fagot a été président de l'APEI de Saint-Amand-Montrond de 1980 à 2002, année de son décès. C'est sous son impulsion et grâce à son dynamisme et à sa persévérance que l'association a créé et pérennisé près de 23 emplois pour personnes handicapées et un peu plus de 100 places d'hébergement. Ainsi, en appelant l'ensemble des services d'hébergement, « Foyers Bernard-Fagot », le conseil d'administration a voulu lui rendre hommage. Nos services d'hébergement offrent, pour 106 personnes, cinq formules d'accueil distinctes, fonction de l'âge et du degré d'autonomie de chacun.



MAISONS INDIVIDUELLES



Hébergement pour 6 résidents, face à une perte d'autonomie, (personnes n'étant plus prises en charge au foyer). Maisons fonctionnelles, domotisées et conformes aux normes d'accessibilité.

Les résidents bénéficient de services personnalisés du foyer selon leurs besoins : loisirs, repas, ...



# Nos Projets

## L'ACCUEIL SPÉCIFIQUE À DESTINATION DES PERSONNES HANDICAPÉES VIEILLISSANTES



**FOYER MARENGO - HABITAT INCLUSIF**

Actuellement, nous menons un nouveau projet « d'habitat inclusif » d'une capacité de 25 personnes. Destiné à favoriser l'accueil des personnes vieillissantes et également à proposer une solution de répit pour les aidants familiaux grâce à un service d'accueil ambulatoire, renforçant ainsi la continuité de notre action sociale et solidaire.

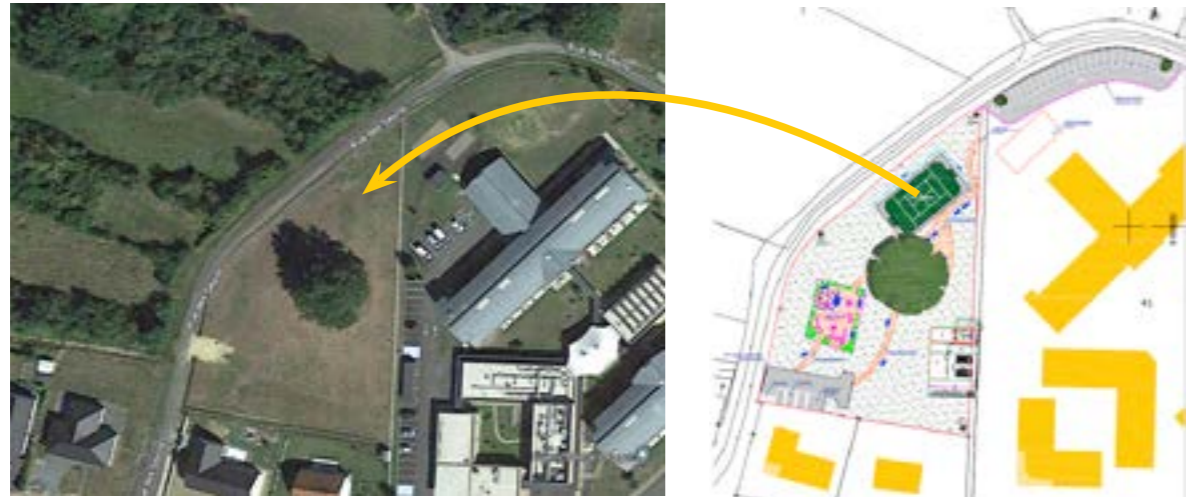

**CITY STADE - SAINT-AMAND-MONTROND**

L'inclusion par le sport c'est la création d'un city stade. Lieu d'échange et de partage de plusieurs activités possibles au sein d'un ensemble de résidences pavillonnaires à côté de nos foyers. Conçu d'une part pour les personnes accueillies dans nos structures et d'autre part pour les enfants et familles isolées au sein d'un territoire urbain non adapté à la pratique sportive. C'est en faisant pour les autres qu'on progresse et qu'on grandit le mieux.



## ALLEZ LE PLUS LOIN ENSEMBLE



C'est un moment où tout le monde enfle le même maillot pour partager un moment de compétition sans se départager mais simplement pour aller le plus loin possible, ensemble, avec une reconnaissance du dépassement de chacun et pas une reconnaissance d'un handicap...



## LA COMPÉTITION AU SERVICE DE LA COHÉSION



# Nos Savoir — Faire —

## Sommaire



### L'Artisanerie



FABRICATION - ASSEMBLAGE - CONDITIONNEMENT DE PRODUITS D'HYGIÈNE ET D'ENTRETIEN  
79 SALARIÉS EN SITUATION DE HANDICAP

### Le Verdier



FABRICATION - ASSEMBLAGE - CONDITIONNEMENT D'ARTICLES DE PAPETERIE  
PETIT MATÉRIEL DE BUREAU - PARAPHARMACIE  
43 SALARIÉS EN SITUATION DE HANDICAP

### Vernet



ENTRETIEN & HYGIÈNE DES LOCAUX - LAVAGE DES VÉHICULES - SOUS-TRAITANCE  
INDUSTRIELLE - BLANCHISSERIE - ESPACES VERTS - CUISINE - CARTONNAGE  
INTÉGRATION PROFESSIONNELLE - AIDE AU TRAVAIL



## DES PRODUITS EN FAVEUR DE L'INSERTION

# GAMMES

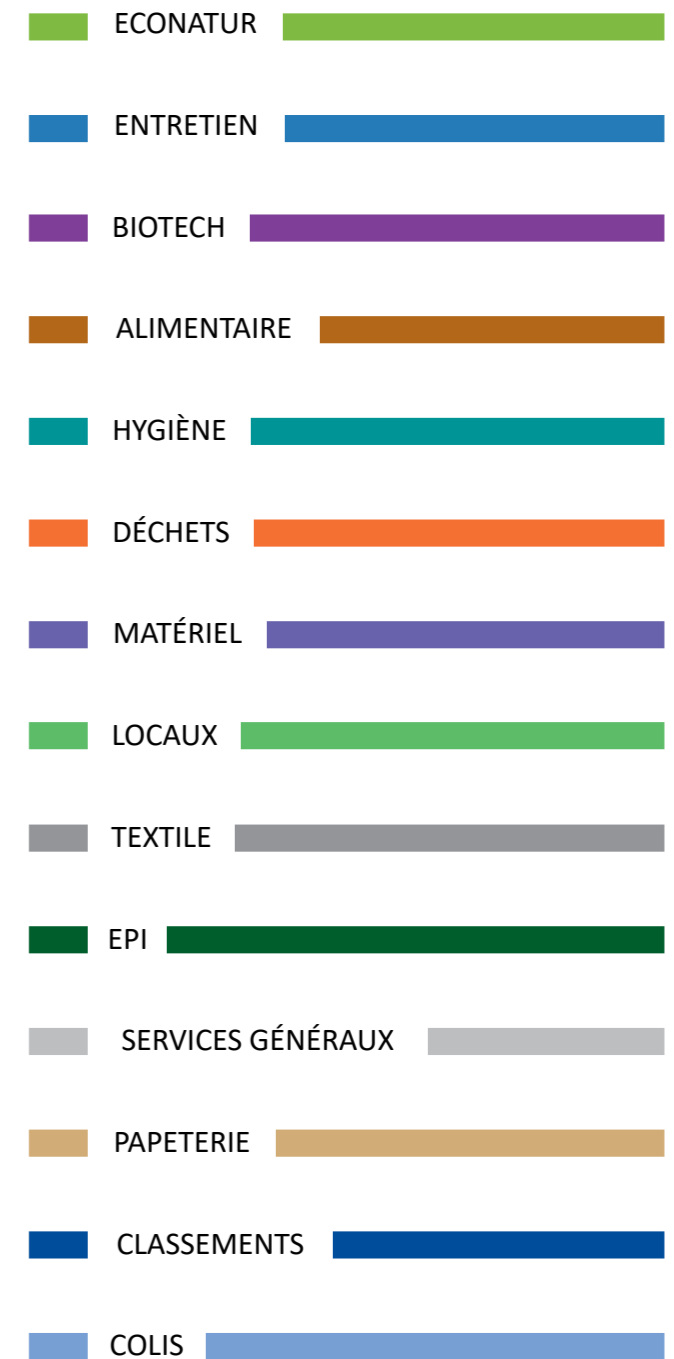

# GAMME ECONATUR

Notre engagement Qualité & Respect de l'Environnement



L'Artisanerie



Le Verdier



L'Artisanerie



# GAMME ECONATUR

Notre engagement Qualité & Respect de l'Environnement



**V962**  
**CORBILLE DE TRI SÉLECTIF**  
Carton kraft brun  
Couvercle couleurs au choix :  
bleu, rouge, vert ou jaune



**V963**  
**CORBILLE DE TRI SÉLECTIF**  
Carton kraft brun - 60 L  
Couleurs panachées



**V970**  
**COLLECTEUR DE PAPIER**  
Avec couvercle. 3 poignées. Témoin  
de remplissage. Intérieur et  
extérieur en carton kraft brun



**F290**  
**CORBILLE À PAPIER**  
Carton kraft brun



**F300**  
**PRÉSENTOIR MURAL**  
Carton kraft brun



**F292**  
**POT À CRAYONS**  
4 compartiments  
Carton kraft brun



**F294**  
**CORBILLE À COURRIER**  
**SUPERPOSABLE**  
Pour format A4  
Carton kraft brun



**F296**  
**BOÎTE DE CLASSEMENT À PAN**  
**COUPÉ**  
Carton kraft brun



# GAMME ECONATUR

Notre engagement Qualité & Respect de l'Environnement



A466

**TORCHON ESSUIES-MAINS  
ESSUIE-TOUT NID D'ABEILLES**  
52 X 82 cm - 100% coton - 260 g/m<sup>2</sup>



A491

**SERVIETTE ESSUIES-MAINS  
ÉPONGE BLEU**  
50 X 90 cm - 100% coton - 400 g/m<sup>2</sup>



A493

**SERVIETTE ESSUIE-MAINS ÉPONGE  
JACQUARD ATELIER**  
50 X 90 cm - 100% coton - 350 g/m<sup>2</sup>



10 kg

A564

**CHIFFON TEXTILE TISSÉ BLANC  
OPTIQUE EXTRA.** Coupe formatée  
Drap blanc coton extra fin sans couture



10 kg

A574

**CHIFFON TEXTILE JERSEY COULEUR**  
Polo et tee-shirt couleur coton fin



T234

**BAVOIR ENFANT ÉPONGE "TEDDY"**  
50 x 35 cm - 100% coton - 400 g/m<sup>2</sup>



Photographies non contractuelles  
Reproduction interdite. © APEI 2024

# GAMME ECONATUR

Notre engagement Qualité & Respect de l'Environnement



A638

**PURE DOUCEUR 100.** Boîte plate  
Pure ouate de cellulose. Extra doux,  
absorbant et résistant - 2 épaisseurs



A639

**PURE DOUCEUR 100.** Boîte cube  
Pure ouate de cellulose. Extra doux,  
absorbant et résistant - 2 épaisseurs



A653

**TAD PREMIUM 100 - H2**  
Pure ouate de cellulose texturée  
Décor laurier mauve  
2 épaisseurs - Traité WS



A655

**TAD PREMIUM 150 - H2**  
Pure ouate de cellulose texturée  
Décor laurier bleu  
2 épaisseurs - Traité WS



A663

**CONFORT SOFT 250 - H3**  
50% fibres recyclées - 50% fibres  
vierges issues de forêts certifiées.  
Décor laurier blanc. Traité WS



A666

**CONFORT SOFT 250 - H3**  
100% fibres recyclées - 2 épaisseurs  
Décor laurier vert. Traité WS



Photographies non contractuelles  
Reproduction interdite. © APEI 2024

# GAMME ECONATUR

Notre engagement Qualité & Respect de l'Environnement



A349

**NETTOYANT DÉGRAISSANT  
MULTI-SURFACES AGRUMES**  
Nettoie, dégraisse, désodorise toutes  
les petites surfaces lavables



A350

**NETTOYANT DÉGRAISSANT  
MULTI-SURFACES AGRUMES**  
Nettoie, dégraisse, désodorise toutes  
les surfaces lavables



A435

**NETTOYANT DÉGRAISSANT  
MULTI-SURFACES AGRUMES**  
Nettoie, dégraisse, désodorise toutes  
les surfaces lavables



A343

**NETTOYANT SANITAIRE  
ANTICALCAIRE**  
Nettoie, détartre, désodorise  
et fait briller les sanitaires.



A462

**NETTOYANT SANITAIRE  
ANTICALCAIRE**  
Nettoie, détartre, désodorise  
et fait briller les sanitaires.



A356

**LIQUIDE VAISSELLE MAIN**  
Sans parfum, sans colorant  
Concentré en actifs  
dégraissants



A440

**LIQUIDE VAISSELLE MAIN**  
Sans parfum, sans colorant  
Concentré en actifs  
dégraissants



A346

**NET WC GEL**  
Nettoyant détartrant gel actif  
Nettoie, détartre, désodorise



A458

**NET WC GEL**  
Nettoyant détartrant gel actif  
Nettoie, détartre, désodorise



A418

**AIRFLOR MÈCHE DÉSODORISANTE**  
Menthe



Photographies non contractuelles  
Reproduction interdite. © APEI 2024

# GAMME ECONATUR

Notre engagement Qualité & Respect de l'Environnement



A015

**FRANGE DE LAVAGE MICROFIBRE  
(MICRO ACTIVA)**  
Pour support pliable



A395

**NET VITRES**  
Fraîcheur printanière  
Nettoie, dégraisse et fait briller



A445

**NET VITRES**  
Fraîcheur printanière  
Nettoie, dégraisse et fait briller

RÉDUISONS NOS DÉCHETS  
DONNONS UNE NOUVELLE VIE  
À NOS EMBALLAGES  
Remettez votre berlingot à votre délégué lors de sa venue

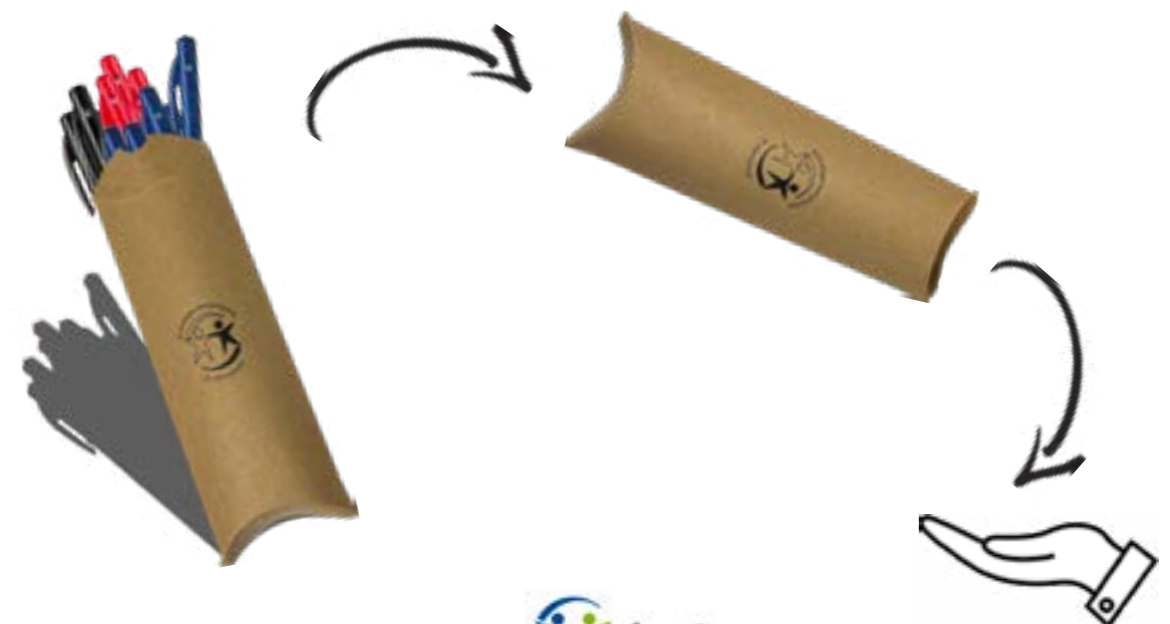

Photographies non contractuelles  
Reproduction interdite. © APEI 2024



# GAMME ECONATUR

Notre engagement Qualité & Respect de l'Environnement



A634

**BLANC 200**  
Dévidage central et latéral  
200 formats - 2 épaisseurs



A643

**BLANCHE EXTRA PLUS 450**  
Dévidage central  
450 formats - 2 épaisseurs



A646

**CHAMOIS 450**  
Dévidage central  
450 formats - 2 épaisseurs



A678

**BLANC 1000**  
Dévidage central possible  
1000 formats - 2 épaisseurs



A680

**CHAMOIS 1000**  
Dévidage central possible  
1000 formats - 2 épaisseurs



A685

**BLEU 1000**  
Dévidage central possible  
1000 formats - 2 épaisseurs



Photographies non contractuelles  
Reproduction interdite. © APEI 2024

# GAMME ECONATUR

Notre engagement Qualité & Respect de l'Environnement

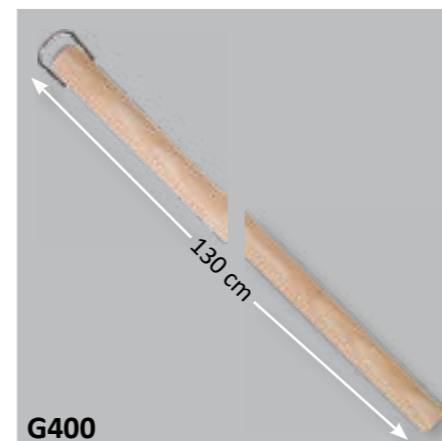

G400

**MANCHE**  
Bois poncé

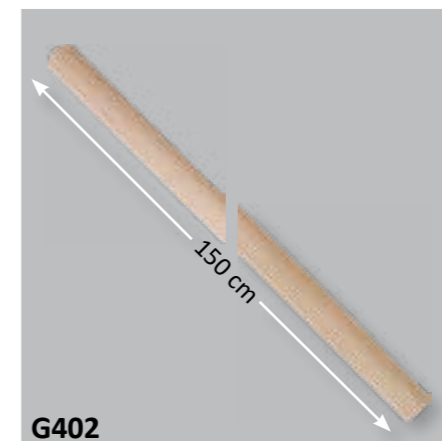

G402

**MANCHE CANTONNIER**  
Bois poncé

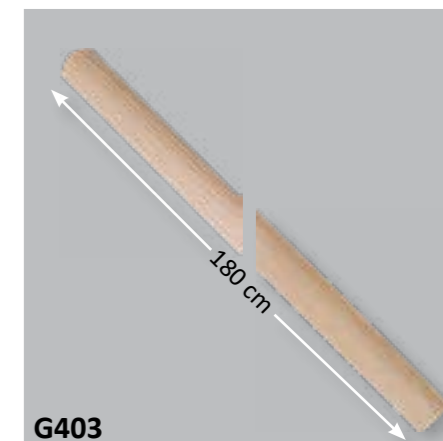

G403

**MANCHE CANTONNIER**  
Bois poncé



G404

**MANCHE**  
Bois poncé. Embout à vis.



G406

**MANCHE**  
Bois poncé vernis. Embout à vis.

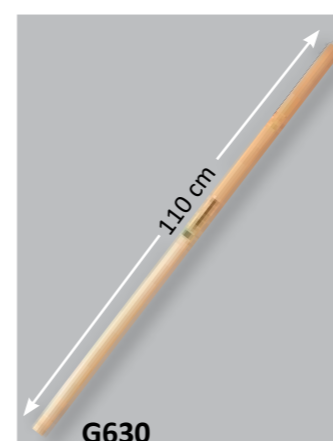

G630

**MANCHE BOIS FRÊNE**  
**PONCÉ CIRÉ. Ø 40 mm**  
Pour pelles col de cygne



G633

**MANCHE BOIS FRÊNE**  
**PONCÉ CIRÉ. Ø 40 mm**  
Pour pelles alu extra creuse ou alu auto



G635

**MANCHE BOIS FRÊNE**  
**PONCÉ CIRÉ. Ø 40 mm**  
Pour pelles ABS extra creuse

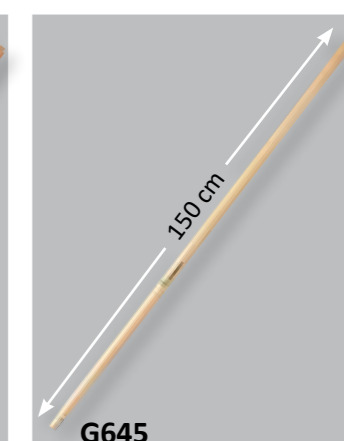

G645

**MANCHE BOIS FRÊNE**  
**PONCÉ CIRÉ. Ø 28 mm**  
Pour râteau forgé et balai bouleau polypro



Photographies non contractuelles  
Reproduction interdite. © APEI 2024

# GAMME ECONATUR

Notre engagement Qualité & Respect de l'Environnement



ADHÉSIVE

V500

**ENVELOPPE BLANCHE**  
114 x 162 mm  
Trapézoïdale - 90 g/m<sup>2</sup>



ADHÉSIVE

V503/V503 1

**ENVELOPPE BLANCHE**  
110 x 220 mm  
Trapézoïdale - 90 g/m<sup>2</sup>



AUTO-COLLANTE

V503 9

**ENVELOPPE BLANCHE**  
110 x 220 mm  
Trapézoïdale - 80 g/m<sup>2</sup>



ADHÉSIVE

V504/V504 1

**ENVELOPPE BLANCHE À FENÊTRE**  
110 x 220 mm. Fenêtre 45 x 100 mm  
Trapézoïdale - 90 g/m<sup>2</sup>



AUTO-COLLANTE

V504 9

**ENVELOPPE BLANCHE À FENÊTRE**  
110 x 220 mm. Fenêtre 45 x 100 mm  
Trapézoïdale - 80 g/m<sup>2</sup>



ADHÉSIVE

V505

**ENVELOPPE BLANCHE À FENÊTRE**  
110 x 220 mm. Fenêtre 35 x 100 mm  
Trapézoïdale - 90 g/m<sup>2</sup>



AUTO-COLLANTE

V505 9

**ENVELOPPE BLANCHE À FENÊTRE**  
110 x 220 mm. Fenêtre 35 x 100 mm  
Trapézoïdale - 80 g/m<sup>2</sup>



Photographies non contractuelles  
Reproduction interdite. © APEI 2024

# GAMME ECONATUR

Notre engagement Qualité & Respect de l'Environnement



AUTO-ADHÉSIVE  
GOMMÉE

V508 2

**ENVELOPPE BLANCHE À FENÊTRE  
VITREX.** 114 x 229 mm  
Fenêtre 35 x 100 mm - 80 g/m<sup>2</sup>



AUTO-ADHÉSIVE  
GOMMÉE

V508 3

**ENVELOPPE BLANCHE À FENÊTRE  
VITREX.** 114 x 229 mm  
Fenêtre 45 x 100 mm - 80 g/m<sup>2</sup>



AUTO-ADHÉSIVE  
GOMMÉE

V508 4

**ENVELOPPE BLANCHE**  
114 x 229 mm. 80 g/m<sup>2</sup>



AUTO-ADHÉSIVE  
GOMMÉE

V508 5

**ENVELOPPE BLANCHE À FENÊTRE  
VITREX.** 115 x 225 mm  
Fenêtre 45 x 100 mm - 80 g/m<sup>2</sup>



V509

**ENVELOPPE BLANCHE À FENÊTRE**  
162 x 229 mm. Fenêtre 45 x 100 mm  
Trapézoïdale - 90 g/m<sup>2</sup>



V515

**POCHETTE BLANCHE**  
Format A5  
Velin blanc - 90 g/m<sup>2</sup>



V516

**POCHETTE BLANCHE**  
229 x 324 mm  
Velin blanc - 90 g/m<sup>2</sup>



V517

**POCHETTE BLANCHE À FENÊTRE**  
229 x 324 mm - Fenêtre 50 x 110 mm  
Velin blanc - 90 g/m<sup>2</sup>



V269

**CHEMISE COINS A4**  
Ouverture 2 côtés. Polypropylène 100%  
recyclé. Transparent. Épaisseur : 12/100e  
22 x 31 cm



Photographies non contractuelles  
Reproduction interdite. © APEI 2024

# GAMME ECONATUR

Notre engagement Qualité & Respect de l'Environnement



**V510/V510 1**  
**POCHETTE KRAFT** Format A5  
Vergé  
90 g/m<sup>2</sup>



**V511**  
**POCHETTE KRAFT** 176 x 250 mm  
Vergé  
90 g/m<sup>2</sup>



**V512/V512 1**  
**POCHETTE KRAFT** 229 x 324 mm  
Vergé  
90 g/m<sup>2</sup>



**V513**  
**POCHETTE KRAFT**  
260 x 330 mm  
Adour - 120 g/m<sup>2</sup>



**V514**  
**POCHETTE KRAFT À FENÊTRE** 229 x 324 mm  
Fenêtre 50 x 110 mm  
Adour - 90 g/m<sup>2</sup>



**V520**  
**POCHETTE KRAFT À SOUFFLET** 229 x 324 mm  
Soufflet 30 mm  
120 g/m<sup>2</sup>



**V521**  
**POCHETTE KRAFT À SOUFFLET** 260 x 330 mm  
Soufflet 30 mm  
120 g/m<sup>2</sup>



**V545**  
**POCHETTE BULLE PAPIER KRAFT BRUN**  
150 x 215 mm



**V546**  
**POCHETTE BULLE PAPIER KRAFT BRUN**  
220 x 265 mm



**V547**  
**POCHETTE BULLE PAPIER KRAFT BRUN**  
270 x 360 mm



Photographies non contractuelles  
Reproduction interdite. © APEI 2024

# GAMME ECONATUR

Notre engagement Qualité & Respect de l'Environnement



**BOÎTE ARCHIVE**  
Dos de 8 cm  
**V110**  
**IMPRIMÉE BLEU**  
34 x 25 mm. Carton fort.  
Montage manuel



**BOÎTE ARCHIVE**  
Dos de 8 cm  
**V111**  
**IMPRIMÉE JAUNE**  
34 x 25 mm. Carton fort.  
Montage manuel



**BOÎTE ARCHIVE**  
Dos de 8 cm  
**V112**  
**IMPRIMÉE ROUGE**  
34 x 25 mm. Carton fort.  
Montage manuel



**BOÎTE ARCHIVE**  
Dos de 8 cm  
**V113**  
**IMPRIMÉE VERT**  
34 x 25 mm. Carton fort.  
Montage manuel



**BOÎTE ARCHIVE**  
Dos de 8 cm  
**V114**  
**IMPRIMÉE ORANGE**  
34 x 25 mm. Carton fort.  
Montage manuel



**BOÎTE ARCHIVE**  
Dos de 8 cm  
**V115**  
**IMPRIMÉE PANACHÉE**  
34 x 25 mm. Carton fort.  
Montage manuel. 5 couleurs :  
bleu, jaune, rouge, vert et orange



**CAISSE ARCHIVE**  
**V150**  
**IMPRIMÉE** 53 x 27 x 35 cm  
Carton extra-fort  
Montage semi-automatique



**BOÎTE ARCHIVE**  
Dos de 10 cm  
**V145**  
**CARTON KRAFT**  
34 x 25 cm.  
Cannelure apparente.



**BOÎTE ARCHIVE**  
**V170**  
**À TIROIR**  
Dim. boîte extérieure 36,5 x 28 x 9 cm  
Hauteur tiroir : 7,8 cm.  
Carton. Montage manuel



**BOÎTE ARCHIVE**  
**V172**  
**À TIROIR**  
Dim. boîte extérieure 36,5 x 28 x 14 cm  
Hauteur tiroir : 12 cm.  
Carton. Montage manuel



Photographies non contractuelles  
Reproduction interdite. © APEI 2024

# GAMME ECONATUR

Notre engagement Qualité & Respect de l'Environnement



V478

**RAMETTE PAPIER A4  
BLANCHEUR 95 CIE**  
500 feuilles 80 g/m<sup>2</sup>  
100% recyclé



V479

**RAMETTE PAPIER A4  
BLANCHEUR 135 CIE**  
500 feuilles 80 g/m<sup>2</sup>  
100% recyclé



V480

**RAMETTE PAPIER A4 BLANC**  
500 feuilles 80 g/m<sup>2</sup>



V482/V482 1

**RAMETTE PAPIER A3**  
500 feuilles 80 g/m<sup>2</sup>



V443

**CHEMISE DE CLASSEMENT**  
A4 perforées à 4 trous  
250 g/m<sup>2</sup>



V746

**MODULE DE CLASSEMENT**  
Plastique noir / multicolore  
5 tiroirs. 347 x 278 x 271 mm



V620

**STYLO BILLE**  
Corps transparent  
Couleurs au choix : bleu, noir, rouge  
ou vert



V621

**STYLO BILLE**  
8 noirs, 8 bleus, 2 rouges et 2 verts  
Corps transparent



V058

**CUBE PAPILLONS ADHÉSIFS**  
4 couleurs. Coloris nature  
Papier recyclé. 400 feuilles  
7,5 x 7,5 cm



Photographies non contractuelles  
Reproduction interdite. © APEI 2024

# NORME ISO AGRÉMENT ESUS



Pour cela, nous nous sommes engagés dans la mise en œuvre et le maintien d'un système de management environnemental, conforme à la **norme ISO 14001**, pour les entreprises adaptées L'Artisanerie et Le Verdirier. Cette démarche constitue la preuve d'une volonté de prendre en compte notre responsabilité sociétale.

Depuis le **30 juillet 2010**, les entreprises adaptées **L'Artisanerie** et **Le Verdirier** sont certifiées **ISO 14001**.

Depuis, notre certification a été renouvelée sans interruption et en dernière date du **19 septembre 2022**, jusqu'au **29 juillet 2025**.

Depuis plus de **30 ans**, écoute, accueil, création d'emplois, tolérance pour les personnes en situation de handicap, sont au cœur de l'action de l'**A.P.E.I. de Saint-Amand-Montrond**.

A ces préoccupations sociales, se sont ajoutées des préoccupations économiques, pour pérenniser les structures existantes, améliorer et développer l'action de celles-ci et poursuivre l'objet social de l'association.

Aujourd'hui, il est également nécessaire de réduire les effets dommageables de nos activités sur l'environnement et d'améliorer en permanence nos performances dans ce domaine.



# GAMME ENTRETIEN



L'Artisanerie

L'Artisanerie

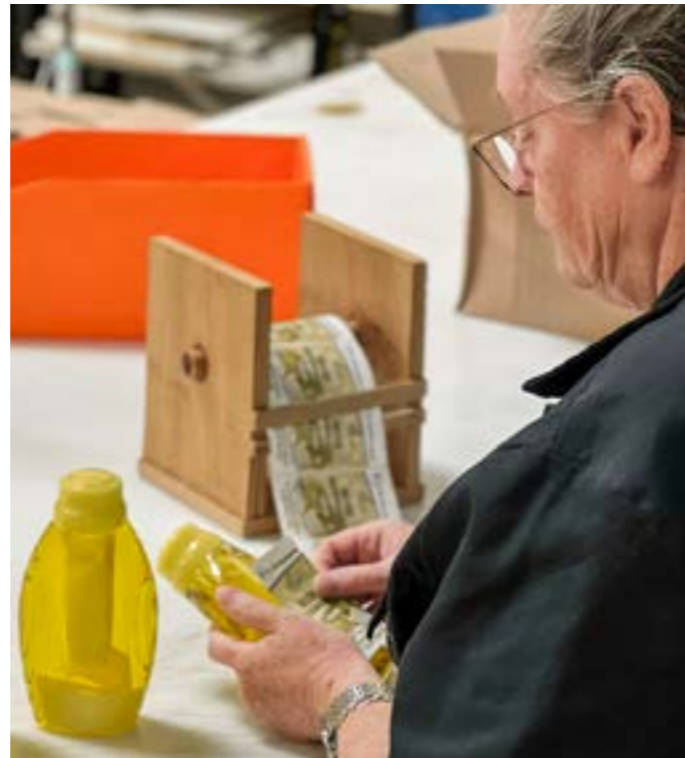

L'Artisanerie

L'Artisanerie



# GAMME ENTRETIEN



**A408**  
AIRFLOR DÉSORODISANT NATURE  
Bocage



**A403**  
AIRFLOR DÉSORODISANT NATURE  
Coquelicot



**A406**  
AIRFLOR DÉSORODISANT NATURE  
Citron vert



**A402**  
AIRFLOR DÉSORODISANT NATURE  
Parfums panachés :  
Coquelicot, Citron vert et Bocage



**A785**  
AIRFLOR PARFUM D'AMBIANCE  
Miss Flor



**A800**  
AIRFLOR PARFUM D'AMBIANCE  
Parfums panachés :  
Vanille-cannelle, Senteurs nocturnes,  
Senteurs d'orient et Miss Flor



**A789**  
AIRFLOR PARFUM D'AMBIANCE  
Senteurs nocturnes



**A792**  
AIRFLOR PARFUM D'AMBIANCE  
Vanille-cannelle



**A794**  
AIRFLOR PARFUM D'AMBIANCE  
Senteurs d'orient



# GAMME ENTRETIEN



**A410**  
**AIRFLOR MÈCHE DÉSORISANTE**  
Fruits rouges



**A411**  
**AIRFLOR MÈCHE DÉSORISANTE**  
Marine



**A413**  
**AIRFLOR MÈCHE DÉSORISANTE**  
Citron vert



**A414**  
**AIRFLOR MÈCHE DÉSORISANTE**  
Lavande



**A416**  
**AIRFLOR MÈCHE DÉSORISANTE**  
Floral



**A421**  
**AIRFLOR MÈCHE DÉSORISANTE**  
Parfums panachés :  
Fruits rouges, Marine, Citron vert  
Lavande, Floral et Menthe



**A418**  
**AIRFLOR MÈCHE DÉSORISANTE**  
Menthe



# GAMME ENTRETIEN



**A398**  
**CLIP AIR FLOR DÉSORISANT**  
Mangue



**A396**  
**CLIP AIR FLOR DÉSORISANT**  
Agrume



**A397**  
**AIRFLOR GEL SENTEUR**  
Jardin d'orangers



**A819**  
**DIFFUSEUR AUTOMATIQUE DE**  
**PARFUM.** Couvre jusqu'à 100 m<sup>2</sup>  
Programmable toutes les 7,5-15-30  
et 45 min. Mode 24H, NUIT et JOUR



**A822**  
**AIRFLOR AMBIANCE RECHARGE**  
Parfums panachés :  
Nocturne, Eau essentielle,  
Davania et Mistral



**A399**  
**AIRFLOR GEL SENTEUR**  
Marine



**A730**  
**SEPTILIN+ LINGET'**  
Antiseptie des mains et de la peau  
Désinfection des surfaces et objets



**A734**  
**CLINET'MAINS INDUSTRIES**  
Lingettes nettoyantes à usage pro  
Nettoient et dégraissent : mains,  
objets, machines



**A756**  
**LINGETTES NETTOYANTES**  
**MULTI-USAGES**  
Bactéricide, levuricide, virucide

# GAMME ENTRETIEN



**A372**  
**PASTILLES JAVEL EFFERVESCENTES**  
Désinfectant universel chloré



**A374**  
**PASTILLES JAVEL EFFERVESCENTES**  
Désinfectant universel chloré



**A705**  
**SPRAY DÉSINFECTANT DE SURFACES**  
Désinfectant, sans rinçage, pour les surfaces et les équipements en contact avec les aliments



**A366**  
**LESSIVE Poudre POUR LE LINGE**  
Concentrée. Parfum fleuri délicat  
Bio-activée, active dès 30° - 4,5 kg



**A369**  
Sans phosphate - 120 doses



Photographies non contractuelles  
Reproduction interdite. © APEI 2024

# GAMME ENTRETIEN



**A343**  
**NETTOYANT SANITAIRE ANTICALCAIRE**  
Nettoie, détartre, désodorise et fait briller les sanitaires.



**A346**  
**NET WC GEL**  
Nettoyant détartrant gel actif  
Nettoie, détartre, désodorise



**A380**  
**TABLETTES WC ACTION CUVETTE**  
Sans phosphate. Détartre, assainit, désodorise le fond de la cuvette



**A462**  
**NETTOYANT SANITAIRE ANTICALCAIRE**  
Nettoie, détartre, désodorise et fait briller les sanitaires.



**A458**  
**NET WC GEL**  
Nettoyant détartrant gel actif  
Nettoie, détartre, désodorise



**A388**  
**BLOCS WC URINOIRS**  
Fraîcheur bleue. Nettoie, assainit, désodorise, détartre



**A383**  
**WC BLOCS CUVETTE LIQUIDE CONCENTRÉ**  
Nettoie, parfume, anti-tartre



**A385**  
**GRILLE URINOIR PARFUMÉE**  
Fruits rouges  
Protège et désodorise.  
Evite de boucher la tuyauterie



**A425**  
**COMBINÉ WC PLASTIQUE**  
Balayette boule + support



Photographies non contractuelles  
Reproduction interdite. © APEI 2024

# GAMME ENTRETIEN



1 L

A357

**LIQUIDE VAISSELLE MAIN CITRON**  
Super concentré, super dégraissant  
Nettoie, dégraisse et fait briller



5 L

A441



1 L

A356

**LIQUIDE VAISSELLE MAIN**  
Sans parfum, sans colorant  
Concentré en actifs dégraissants



5 L

A440



# GAMME ENTRETIEN



A349

**NETTOYANT DÉGRAISSANT  
MULTI-SURFACES AGRUMES**  
Nettoie, dégraisse, désodorise toutes  
les petites surfaces lavables



A351

**NETTOYANT CONCENTRÉ 1L**  
Pin des Landes. Nettoie, dégraisse,  
assainit, désodorise :  
sols, surfaces, murs, sanitaires, ...



B050

**VINAIGRE DE NETTOYAGE  
SURPUISSANT**  
Concentré - 14°  
Détergent, dégraissant et détartrant



A350

**NETTOYANT DÉGRAISSANT  
MULTI-SURFACES AGRUMES**  
Nettoie, dégraisse, désodorise toutes  
les surfaces lavables



A310

**POMPE DOSEUSE**  
Pour bidon de 5L



B052

**VINAIGRE DE NETTOYAGE  
SURPUISSANT**  
Concentré - 14°  
Détergent, dégraissant et détartrant



A435

**NETTOYANT DÉGRAISSANT  
MULTI-SURFACES AGRUMES**  
Nettoie, dégraisse, désodorise toutes  
les surfaces lavables



A431

**NETTOYANT CONCENTRÉ 5L**  
Pin des Landes. Nettoie, dégraisse,  
assainit, désodorise :  
sols, surfaces, murs, sanitaires, ...



B054

**VINAIGRE DE NETTOYAGE  
SURPUISSANT**  
Concentré - 14°  
Détergent, dégraissant et détartrant



# GAMME ENTRETIEN



**A429**  
**DÉTERGENT CONCENTRÉ SAVON NOIR LIQUIDE**  
Nettoyant multi-usages, multi-surfaces à base d'huile d'olive



**A451**  
**DÉTERGENT DÉGRAISSANT INDUSTRIEL** Nettoyant puissant et efficace des sols, murs, surfaces en collectivités et industries



**A714**  
**DÉTERGENT DÉGRAISSANT DÉSINFECTANT ALIMENTAIRE** Bactéricide, levuricide. Nettoyage, dégraissage et désinfection des sols et surfaces



**A710**  
**DÉTERGENT DÉSINFECTANT SURODORANT CITRON VERT 5L**  
Bactéricide, fongicide  
Sols et surfaces - Forte rémanence



**A713**  
**DÉTERGENT DÉSINFECTANT SURODORANT COQUELICOT 5L**  
Bactéricide, fongicide  
Sols et surfaces - Forte rémanence



**A395**  
**NET VITRES**  
Fraîcheur printanière  
Nettoie, dégraisse et fait briller



**A445**  
**NET VITRES**  
Fraîcheur printanière  
Nettoie, dégraisse et fait briller



Photographies non contractuelles  
Reproduction interdite. © APEI 2024

# GAMME ENTRETIEN



**A354**  
**SOLUTION NETTOYANTE ANTISTATIQUE** Informatique, bureautique, multimédia, écrans : plats, LCD, Plasma, tactiles, portables



**A358**  
**LIQUIDE NETTOYANT ANTISTATIQUE** Informatique, bureautique, surfaces modernes : écrans, claviers, tableaux blancs, multimédia



**A360**  
**LIQUIDE NETTOYANT ANTISTATIQUE** Informatique, bureautique, surfaces modernes : écrans, claviers, tableaux blancs, multimédia



**A873**  
**KIT NETTOYANT ÉCRANS PLATS**  
3 souffleurs (A867)  
+ 3 solutions antistatiques (A354)  
+ 15 chiffons (A363)



**A867**  
**SOUFFLEUR DÉPOUVSIÉRANT GAZ SEC MULTI-POSITIONS**  
Informatique, bureautique, électronique



**A877**  
**KIT NETTOYANT ÉCRANS PLATS**  
3 souffleurs (A867)  
+ 3 solutions antistatiques (A354)  
+ 15 chiffons (A363)



**A355**  
**LINGETTES NETTOYANTES OPTIQUE**  
Lingettes imprégnées à usage unique



**A581**  
**CARRÉ MICROFIBRE POUR LUNETTES**  
70% polyester - 30% polyamide  
Sachets de 2 blancs et 2 gris  
220 g/m<sup>2</sup> - 16 x 16 cm



**A839**  
**NETTOYANT MULTI-SURFACES**  
Mousse active  
Aérosol 400 ml



Photographies non contractuelles  
Reproduction interdite. © APEI 2024

# GAMME ENTRETIEN



**A143**  
**ÉPONGE VÉGÉTALE BLONDE**  
Modèle n°2  
90 x 70 x 30 mm



**A145**  
**ÉPONGE VÉGÉTALE BLONDE**  
Modèle n°4  
140 x 100 x 35 mm



**A150**  
**ÉPONGE VÉGÉTALE BLONDE**  
Modèle n°6  
155 x 120 x 40 mm



**A155**  
**ÉPONGE VÉGÉTALE BLONDE**  
Modèle n°8  
155 x 120 x 48 mm



**A009**  
**GOMME DÉTACHANTE**  
110 x 63 x 38 mm



**A175**  
**ÉPONGE VÉGÉTALE BRUNE**  
**GROS TRAVAUX**  
Résistance accrue 155 x 100 x 50 mm



**A113**  
**ÉPONGE MICROFIBRE BI-TEXTURE**  
**BLEUE**  
140 x 90 x 30 mm

# GAMME ENTRETIEN



**A185**  
**NÉTINOX ÉPONGE SPIRALE**  
Qualité 60 gr. Eponge à récurer  
en acier inoxydable

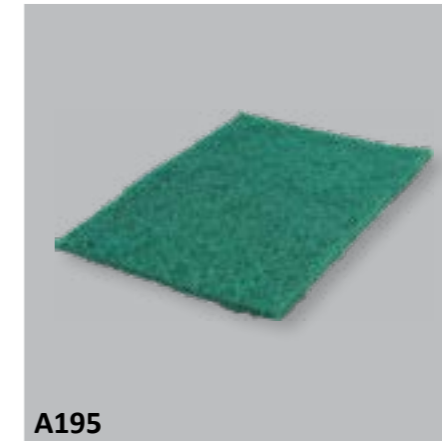

**A195**  
**TAMPON À RÉCURER VERT**  
Récurage courant des surfaces  
résistantes 160 x 225 mm



**A200**  
**ROULEAU À RÉCURER VERT**  
Récurage courant des surfaces  
résistantes 160 x 5000 mm



**A194**  
**ÉPONGE VÉGÉTALE GRATTANTE**  
130 x 90 x 28 mm



**A192**  
**ÉPONGE VÉGÉTALE GRATTANTE**  
**ERGONOMIQUE VERTE**  
149 x 86 x 28 mm



**A193**  
**ÉPONGE VÉGÉTALE GRATTANTE**  
100 x 70 x 28 mm



**A190**  
**ÉPONGE VÉGÉTALE GRATTANTE**  
**BLANCHE**  
130 x 90 x 28 mm



**A112**  
**ÉPONGE MICROFIBRE BI-TEXTURE**  
**GRISE**  
130 x 90 x 25 mm



**A122**  
**TAMPON MICROFIBRE BI-MATIÈRE**  
1 face grattante. 1 face absorbante  
200 x 140 x 15 mm

# GAMME BIOTECH



# GAMME BIOTECH



**B030**  
**DÉSODORISANT TROPIQUES**  
BIOTECHnologie  
Destructeur d'odeurs ambiantes



**B035**  
**NETTOYANT SANITAIRE**  
**CONCENTRÉ MULTI-USAGES**  
BIOTECHnologie  
Formule concentrée gélifiée



## BIOTECHNOLOGIES :

L'EFFICACITÉ HIGH-TECH

ECOBASE est le fruit de **30 ans d'expertise** en R&D et recherche fondamentale en partenariat avec des centres de recherche de renommée mondiale tel que le CNRS.

**Issue des biotechnologies et de procédés exclusifs, ECOBASE allie les technologies de pointe à l'intelligence du vivant** et offre une alternative efficace aux produits issus de la chimie.



## DES PRINCIPES ACTIFS

ISSUS DU VIVANT

**Biosurfactants** : surfactants 100% naturels et facilement biodégradables jusqu'à 500 fois plus efficaces que les surfactants issus de la chimie ou du végétal.

**Micro-organismes** sélectionnés pour leur capacité à digérer des matières organiques. En préparant l'effluent au rejet, ils participent à l'entretien des canalisations.



## CONFORT, SÉCURITÉ

ÉCORESPONSABILITÉ

- Des formules labellisées ECOCERT
- Un large choix de conditionnements de 1 L à 1000 L
- Des flacons recharges 750 mL vides pour les produits concentrés
- Des accessoires de dosage livrés avec bidons 5 L : pompe doseuse pour les produits concentrés, robinet verseur pour les produits prêts à l'emploi
- La poche souple 5 L : 70% de plastique en moins. Livrée avec robinet verseur.



# GAMME ALIMENTAIRE



L'Artisanerie



L'Artisanerie



L'Artisanerie



# GAMME ALIMENTAIRE



18 cl



V975

**GOBELET CARTON**  
Compatible distribution manuelle

8 cl



V976

**GOBELET CARTON**

15 cl



V977

**GOBELET CARTON**

25 cl



V978

**GOBELET CARTON**



# GAMME ALIMENTAIRE



**G278**  
**BROSSE MAIN TONNEAU ALIMENTAIRE**  
Support polypropylène  
Fibres polyester dures (long. 45 mm)



**G286**  
**BALAI LAVE-PONT ALIMENTAIRE**  
Support polypropylène  
Fibres polyester 1/2 dures



**G288**  
**BALAI DROIT ALIMENTAIRE**  
Polypropylène  
Fibres polyester souples



**G290**  
**BALAI DROIT ALIMENTAIRE**  
Support polypropylène  
Fibres polyester souples



**G396**  
**RACLETTE SOL ALIMENTAIRE**  
Mousse blanche. Support polypropylène.  
Non stérilisable. Coloris au choix : bleu, jaune, rouge, blanc ou vert



**G398**  
**RACLETTE SOL ALIMENTAIRE**  
Mousse blanche. Support polypropylène.  
Non stérilisable. Coloris au choix : bleu, jaune, rouge, blanc ou vert

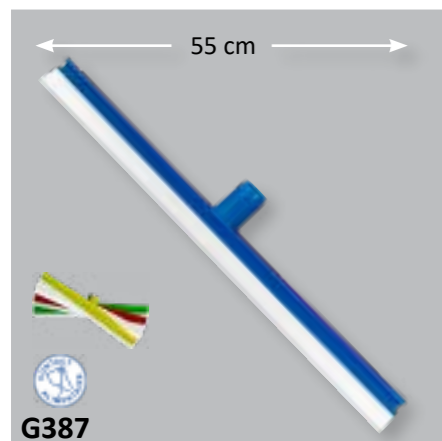

**G387**  
**RACLETTE SOL ALIMENTAIRE MONOLAME**  
Lame blanche. Résistance au froid -80°C.  
Stérilisable à +140°C. Coloris au choix : bleu, jaune, rouge, blanc et vert

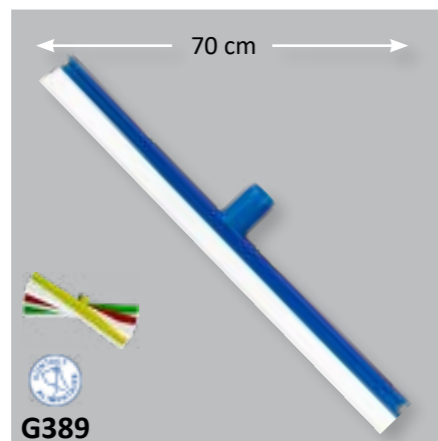

**G389**  
**RACLETTE SOL ALIMENTAIRE MONOLAME**  
Lame blanche. Résistance au froid -80°C.  
Stérilisable à +140°C. Coloris au choix : bleu, jaune, rouge, blanc et vert



**G293**  
**RACLETTE TABLE ALIMENTAIRE**  
Manche polypro, monolame caoutchouc naturel. Stérilisable en autoclave de -30°C à +130°C

# GAMME ALIMENTAIRE



**G272**  
**BROSSE À ONGLES MULTI-USAGES ALIMENTAIRE**  
Support polypropylène  
Fibres polyester



**G292**  
**SET DE NETTOYAGE BLANC ALIMENTAIRE**  
Pelle et balayette  
Support polypropylène  
Fibres polyester souples



**A036**  
**SEAU ALIMENTAIRE À BEC VERSEUR**  
Fond renforcé et graduation intérieure.  
Résistance aux températures entre -15°C et +60°C



**G296**  
**ACCROCHE-BALAIS ALIMENTAIRE**  
3 supports. Rail aluminium  
Charge maximale : 5 kg par support  
Pour manche de Ø 15 à 35 mm



**G300**  
**MANCHE FIBRE DE VERRE**  
Pour brosse et raclettes alimentaires  
Disponible avec embouts au choix : bleu, jaune, rouge, blanc ou vert



**G305**  
**MANCHE ALUMINIUM ANODISÉ**  
Pour brosse et raclettes alimentaires  
Disponible avec embouts au choix : bleu, jaune, rouge, blanc ou vert



**G647**  
**CISEAUX UNIVERSELS 21 CM**  
Lames en acier inoxydable, adaptées au contact alimentaire  
Anneaux ergonomiques



# GAMME ALIMENTAIRE



**A643**  
**BLANCHE EXTRA PLUS 450**  
 Dévidage central  
 450 formats - 2 épaisseurs



**A649**  
**BLEUE GAUFRÉE 450**  
 Dévidage central  
 450 formats - 2 épaisseurs



**A631**  
**ESSUIE-TOUT MÉNAGER**  
 PREMIUM 64  
 64 formats - 2 épaisseurs



**A634**  
**BLANC 200**  
 Dévidage central et latéral  
 200 formats - 2 épaisseurs



**A637**  
**BLANC 300**  
 Dévidage central possible  
 300 formats - 2 épaisseurs



**A676**  
**TAD PERFORMANCE 750**  
 Dévidage central possible  
 750 formats - 2 épaisseurs



**A685**  
**BLEU 1000**  
 Dévidage central possible  
 1000 formats - 2 épaisseurs



**A678**  
**BLANC 1000**  
 Dévidage central possible  
 1000 formats - 2 épaisseurs



Photographies non contractuelles  
 Reproduction interdite. © APEI 2024

# GAMME ALIMENTAIRE



**A653**  
**TAD PREMIUM 100**  
 Pure ouate de cellulose texturée  
 décor laurier mauve  
 2 épaisseurs - Traité WS



**A655**  
**TAD PREMIUM 150 - H2**  
 Pure ouate de cellulose texturée  
 décor laurier bleu  
 2 épaisseurs - Traité WS



**A663**  
**CONFORT SOFT 250 - H3**  
 50% fibres recyclées - 50% fibres  
 vierges issues de forêts certifiées.  
 Décor laurier blanc. Traité WS



**A666**  
**CONFORT SOFT 250 - H3**  
 100% fibres recyclées - 2 épaisseurs  
 Décor laurier vert. Traité WS



**A600**  
**CHIFFON BLANC NON TISSÉ**  
**POLYVALENT HAUTE PERFORMANCE**  
 Essuyeur haute performance  
 multi-usages. Très absorbant



**A578**  
**CHIFFON BLANC NON TISSÉ**  
**ULTRA RÉSISTANT**  
 Boîte distributrice de 120 formats



Photographies non contractuelles  
 Reproduction interdite. © APEI 2024

# GAMME ALIMENTAIRE



**E001**  
**CHARLOTTE CLIP PP CONFORT BLANCHE**  
 Taille unique - 48 cm  
 100% polypropylène non tissé



**E090**  
**MANCHETTE ÉLASTIQUÉE BLEUE**  
 Polyéthylène 20 µm



**E075**  
**SURCHAUSSURES BLEUES**  
 Taille unique. Polyéthylène 38 g/m<sup>2</sup>  
 Élastique de serrage à la cheville  
 Imperméable



**E070** CE  
**COMBINAISON HAUTE PROTECTION**  
 à capuche PP 65 g/m<sup>2</sup> extra blanche



**E045**  
**TABLIER CONFORT PE 40 EXTRA BLANC GAUFRÉ** Taille unique  
 100% polyéthylène - 40 µm



Photographies non contractuelles  
 Reproduction interdite. © APEI 2024

# GAMME ALIMENTAIRE



**P102**  
**GANTS D'EXAMEN PVC VINYLE SOFT**  
 Sans poudre, ambidextres, non stériles,  
 haute qualité, excellent confort tactile



**P104**  
**GANTS D'EXAMEN LATEX NATUREL**  
 Sans poudre, ambidextres, non stériles  
 Surface extérieure texturée  
 4 tailles panachées



**P112**  
**GANTS NITRILE NOIR**  
 Sans poudre, ambidextres, non stériles  
 Doigts texturés



**P101**  
**GANTS D'EXAMEN PVC VINYLE SOFT**  
 Sans poudre, ambidextres, non stériles,  
 haute qualité, excellent confort tactile  
 4 tailles panachées



**P110**  
**GANTS D'EXAMEN NITRILE BLEU**  
 Sans poudre, ambidextres, non stériles  
 Surface extérieure non texturée



**P111**  
**GANTS NITRILE NOIR**  
 Sans poudre, ambidextres, non stériles  
 Doigts texturés  
 4 tailles panachées



**P107**  
**GANTS D'EXAMEN LATEX NATUREL**  
 Sans poudre, ambidextres, non stériles  
 Surface extérieure texturée



**P108**  
**GANTS D'EXAMEN NITRILE BLEU**  
 Sans poudre, ambidextres, non stériles  
 Surface extérieure non texturée  
 4 tailles panachées



**P125**  
**GANTS LATEX NATUREL ÉPAIS LISSE BLEU** Intérieur support textile  
 Bonne isolation au chaud. Manipulation  
 de produits congelés - Tailles : 7-8-9



Photographies non contractuelles  
 Reproduction interdite. © APEI 2024

# GAMME ALIMENTAIRE



**A860**  
**DÉGRIPPANT MULTI-FONCTIONS**  
 Aérosol 400 ml. Anti-corrosion  
 Anti-humidité. Dégripe, nettoie et  
 lubrifie



**A351**  
**NETTOYANT CONCENTRÉ  
 PIN DES LANDES**  
 Nettoie, dégraisse, assainit, désodorise :  
 sols, surfaces, murs, sanitaires, ...



**A431**  
**NETTOYANT CONCENTRÉ  
 PIN DES LANDES**  
 Nettoie, dégraisse, assainit, désodorise :  
 sols, surfaces, murs, sanitaires, ...



**A349**  
**NETTOYANT DÉGRAISSANT  
 MULTI-SURFACES AGRUMES**  
 Nettoie, dégraisse, désodorise toutes  
 les petites surfaces lavables



**A350**  
**NETTOYANT DÉGRAISSANT  
 MULTI-SURFACES AGRUMES**  
 Nettoie, dégraisse, désodorise toutes  
 les surfaces lavables



**A435**  
**NETTOYANT DÉGRAISSANT  
 MULTI-SURFACES AGRUMES**  
 Nettoie, dégraisse, désodorise toutes  
 les surfaces lavables



**A714**  
**DÉTERGENT DÉGRAISSANT  
 DÉSINFECTANT ALIMENTAIRE**  
 Bactéricide, levuricide. Nettoyage, dégrais-  
 sage et désinfection des sols et surfaces



**A451**  
**DÉTERGENT DÉGRAISSANT INDUSTRIEL**  
 Nettoyant puissant et efficace des sols,  
 murs, surfaces en collectivités et  
 industries



Photographies non contractuelles  
 Reproduction interdite. © APEI 2024

# GAMME ALIMENTAIRE

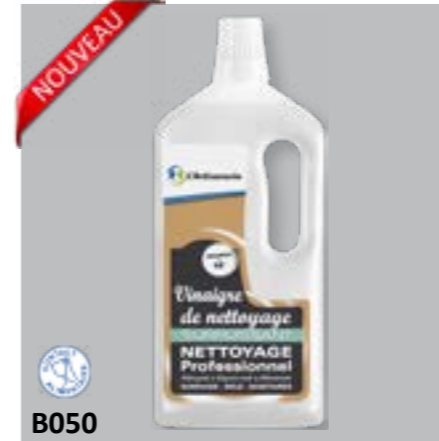

**B050**  
**VINAIGRE DE NETTOYAGE  
 SURPUISSANT**  
 Concentré - 14°  
 Détergent, dégraissant et détartrant



**B052**  
**VINAIGRE DE NETTOYAGE  
 SURPUISSANT**  
 Concentré - 14°  
 Détergent, dégraissant et détartrant



**B054**  
**VINAIGRE DE NETTOYAGE  
 SURPUISSANT**  
 Concentré - 14°  
 Détergent, dégraissant et détartrant



**A310**  
**POMPE DOSEUSE**  
 Pour bidon de 5L



**A395**  
**NET VITRES**  
 Fraîcheur printanière  
 Nettoie, dégraisse et fait briller



**A445**  
**NET VITRES**  
 Fraîcheur printanière  
 Nettoie, dégraisse et fait briller



Photographies non contractuelles  
 Reproduction interdite. © APEI 2024



# GAMME HYGIÈNE



L'Artisanerie

L'Artisanerie



L'Artisanerie

L'Artisanerie

Apei  
FARMACIA  
MUNICIPALE

# GAMME HYGIÈNE



**A261**  
**SAVON LIQUIDE DE MARSEILLE 500ML**  
Nature surgras. Corps et mains  
Extra pur, sans colorant, sans parfum



**A264**  
**SAVON LIQUIDE DE MARSEILLE 5L**  
Nature surgras. Corps et mains  
Extra pur, sans colorant, sans parfum



**A267**  
**SAVON LIQUIDE DE MARSEILLE 500ML**  
Corps et mains  
Parfum orchidée



**A271**  
**SAVON LIQUIDE DE MARSEILLE 5L**  
Corps et mains  
Parfum orchidée



**A273**  
**LOTION LAVANTE COSMÉTIQUE 500ML**  
3 en 1 (pour les mains, le corps et les cheveux). Parfum fleur de pomme



**A274**  
**LOTION LAVANTE COSMÉTIQUE 5L**  
3 en 1 (pour les mains, le corps et les cheveux). Parfum fleur de pomme



**A303**  
**DISTRIBUTEUR À REMPLISSAGE**  
100% recyclable. ABS blanc, bouton poussoir, fermeture à clé  
Niveau visible, pompe anti-goutte



**A304**  
**GEL HYDROALCOOLIQUE**  
Bactéricide, fongicide et virucide  
Pour la désinfection des mains par friction  
Sans rinçage et sans essuyage



Apei  
FARMACIA  
MUNICIPALE

# GAMME HYGIÈNE



A305

**NEPTIGEL - GEL ANTISEPTIQUE HYDROALCOOLIQUE 500ML**  
Bactéricide, fongicide et virucide  
Pour la désinfection des mains par friction



A307

**NEPTIGEL - GEL ANTISEPTIQUE HYDROALCOOLIQUE 1L**  
Bactéricide, fongicide et virucide  
Pour la désinfection des mains par friction



A310

**POMPE DOSEUSE**  
Pour bidon de 5L



A320

**LOTION ANTISEPTIQUE SEPTIBIO 5L**  
Bactéricide, levuricide et virucide  
Antiseptie des mains. Hypoallergénique, sans colorant, sans parfum



A322

**LOTION ANTISEPTIQUE SEPTIBIO 500ML**  
Bactéricide, levuricide et virucide  
Antiseptie des mains. Hypoallergénique, sans colorant, sans parfum



A326

**CRÈME LAVANTE PARFUMÉE 5L**  
Parfum bouquet fleuri  
Pour le mains



A328

**CRÈME LAVANTE PARFUMÉE 500ML**  
Parfum bouquet fleuri  
Pour le mains



# GAMME HYGIÈNE



A336

**PACK DISTRIBUTEUR MURAL**  
Pour cartouche 5L. Hygiénique et esthétique.  
H 40,5 x L 14,5 x P 16 cm



A332

**CRÈME NETTOYANTE INDUSTRIE 5L**  
Action douce et surgraissante  
Pour les mains. Sans solvant ni abrasif



A293

**GEL NETTOYANT NATUREL INDUSTRIE 5L** Sans solvant avec micro-billes végétales. Non irritant pour la peau. Délicatement parfumé



A312

**POMPE SPÉCIAL GEL**  
Pour bidon de 5L  
Dose 28 ml



A330

**CRÈME NETTOYANTE INDUSTRIE 5L**  
Action douce et surgraissante  
Pour les mains. Sans solvant ni abrasif



A291

**GEL NETTOYANT NATUREL INDUSTRIE 5L** Sans solvant avec micro-billes végétales. Non irritant pour la peau. Délicatement parfumé



A334

**CRÈME NETTOYANTE INDUSTRIE 500ML**  
Action douce et surgraissante  
Pour les mains. Sans solvant ni abrasif



A295

**GEL NETTOYANT NATUREL INDUSTRIE 500ML** Sans solvant avec micro-billes végétales. Non irritant pour la peau. Délicatement parfumé



A734

**CLINET'MAINS INDUSTRIES**  
Lingettes nettoyantes à usage pro  
Nettoient et dégraissent : mains, objets, machines

# GAMME HYGIÈNE



**A603**

**PREMIUM 250**  
Douceur prestige  
250 feuilles - 3 épaisseurs



**A604**

**PREMIUM LUXE 150**  
Pure ouate de cellulose  
150 feuilles - 4 épaisseurs



**A605**

**BLANC PREMIUM 300+**  
Gaufré - Pure ouate de cellulose  
300 feuilles - 2 épaisseurs



**A607**

**PREMIUM 400**  
Maxi gaufré douceur  
400 feuilles - 2 épaisseurs



**A611**

**DISTRIBUTEUR PAPIER TOILETTE  
PORTE-ROULEAU ONE**  
Pour un rouleau de 200, 250, 300 ou  
400 feuilles. Inox brossé



**A615**

**PAPIER TOILETTE PAQUET**  
Ouate 100% fibres vierges.  
2 épaisseurs. 224 feuilles enchevêtrées



**A617**

**DISTRIBUTEUR TORK ELEVA T3**  
Pour paquet premium 252. Feuille à feuille.  
Plastique ABS blanc 100% recyclable.  
Anti-choc, fermeture à clé



# GAMME HYGIÈNE



**A620**

Rouleaux **MAXI JUMBO**  
CONFORT 380 - Texture lisse  
2 épaisseurs - 380 m



**A626**

**DISTRIBUTEUR TORK ELEVA T1**  
Pour rouleaux maxi jumbo  
Plastique ABS blanc 100% recyclable  
Anti-choc, fermeture à clé



**A623**

Rouleaux **MINI JUMBO**  
Pure ouate de cellulose  
Prédécoupé - 2 épaisseurs - 140 m



**A629**

**DISTRIBUTEUR TORK ELEVA T2**  
Pour rouleaux mini jumbo  
Plastique ABS blanc 100% recyclable  
Anti-choc, fermeture à clé



# GAMME HYGIÈNE



A363

**CHIFFON BLANC NON TISSÉ  
INFORMATIQUE BUREAUTIQUE**  
Nettoyage matériels informatiques  
Très résistant, absorbant, ne raye pas



A600

**CHIFFON BLANC NON TISSÉ  
POLYVALENT HAUTE PERFORMANCE**  
Essuyeur haute performance  
multi-usages. Très absorbant



A631

**ESSUIE-TOUT MÉNAGER  
PREMIUM 64**  
64 formats - 2 épaisseurs



A634

**BLANC 200**  
Dévidage central et latéral  
200 formats - 2 épaisseurs



A637

**BLANC 300**  
Dévidage central possible  
300 formats - 2 épaisseurs



A643

**BLANCHE EXTRA PLUS 450**  
Dévidage central  
450 formats - 2 épaisseurs

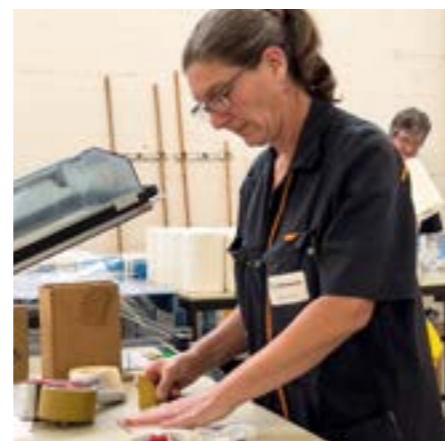

# GAMME HYGIÈNE



A676

**TAD PERFORMANCE 750**  
Dévidage central possible  
750 formats - 2 épaisseurs



A678

**BLANC 1000**  
Dévidage central possible  
1000 formats - 2 épaisseurs



A680

**CHAMOIS 1000**  
Dévidage central possible  
1000 formats - 2 épaisseurs



A685

**BLEU 1000**  
Dévidage central possible  
1000 formats - 2 épaisseurs



A694

**DÉROULEUR SUR PIED MOBILE**  
Pour bobines industrielles avec  
support sac 110L. Acier poudré blanc  
Pour toute bobine jusqu'à Ø 36 cm



A698

**DISTRIBUTEUR PERFORMANCE À  
DÉVIDAGE CENTRAL**  
Pour bobines industrielles. Plastique  
ABS anti-choc 100% recyclable



A646

**CHAMOIS 450**  
Dévidage central  
450 formats - 2 épaisseurs



A649

**BLEUE GAUFRÉE 450**  
Dévidage central  
450 formats - 2 épaisseurs



A651

**DISTRIBUTEUR PERFORMANCE**  
Plastique ABS anti-choc 100% recyclable  
Fermeture à clé

# GAMME HYGIÈNE



# GAMME HYGIÈNE



**A638**  
**PURE DOUCEUR 100.** Boîte plate  
 Pure ouate de cellulose. Extra doux,  
 absorbant et résistant - 2 épaisseurs



**A639**  
**PURE DOUCEUR 100.** Boîte cube  
 Pure ouate de cellulose. Extra doux,  
 absorbant et résistant - 2 épaisseurs



**A653**  
**TAD PREMIUM 100 - H2**  
 Pure ouate de cellulose texturée  
 décor laurier mauve  
 2 épaisseurs - Traité WS



**A655**  
**TAD PREMIUM 150 - H2**  
 Pure ouate de cellulose texturée  
 décor laurier bleu  
 2 épaisseurs - Traité WS



**A663**  
**CONFORT SOFT 250 - H3.** Blanc  
 50% fibres recyclées - 50% fibres  
 vierges issues de forêts certifiées.  
 Traité WS



**A666**  
**CONFORT SOFT 250 - H3.** Vert  
 100% fibres recyclées  
 2 épaisseurs - Traité WS



**A670**  
**DISTRIBUTEUR PORTABLE POUR  
 ESSUIE-MAINS H2**  
 Plastique blanc  
 Pour essuie-mains pliés A653 et A655



**A671**  
**DISTRIBUTEUR ELEVA H2**  
 En plastique ABS blanc 100% recyclable  
 Anti-choc - Fermeture à clé  
 Pour essuie-mains A653 et A655



**A674**  
**DISTRIBUTEUR ELEVA H3**  
 En plastique ABS blanc 100% recyclable  
 Anti-choc - Fermeture à clé  
 Pour essuie-mains A663 et A666

# GAMME DÉCHETS



L'Artisanerie



Vernet

Apei

L'Artisanerie

# GAMME DÉCHETS



<p>100 L</p>  <p><b>A230</b> SAC POUBELLE PLASTIQUE GRIS FONCÉ 60 microns</p>	<p>110 L</p>  <p><b>A235</b> SAC POUBELLE PLASTIQUE GRIS FONCÉ 70 microns</p>	<p>130 L</p>  <p><b>A240</b> SAC POUBELLE PLASTIQUE GRIS FONCÉ 80 microns</p>	<p>160 L</p>  <p><b>A242</b> SAC POUBELLE PLASTIQUE GRIS FONCÉ 80 microns</p>
--	--	--	--

<p>50 L</p>  <p><b>A225</b> SAC POUBELLE PLASTIQUE GRIS FONCÉ 50 microns</p>	<p>30 L</p>  <p><b>A212</b> SAC POUBELLE PLASTIQUE TRANSPARENT 40 microns</p>	<p>50 L</p>  <p><b>A213</b> SAC POUBELLE PLASTIQUE TRANSPARENT 50 microns</p>
--	---	---

<p>110 L</p>  <p><b>A214</b> SAC POUBELLE PLASTIQUE TRANSPARENT 70 microns</p>	<p><b>NOUVEAU</b></p> <p>130 L</p>  <p><b>A241</b> SAC POUBELLE PLASTIQUE TRANSPARENT 80 microns</p>	<p>160 L</p>  <p><b>A243</b> SAC POUBELLE PLASTIQUE TRANSPARENT 80 microns</p>
---	---	---

Apei

# GAMME DÉCHETS



10 L



A210

SAC POUBELLE PLASTIQUE BLANC  
25 microns

20 L



A215

SAC POUBELLE PLASTIQUE BLANC  
30 microns

30 L



A220

SAC POUBELLE PLASTIQUE BLANC  
40 microns

100 L



A231

SAC POUBELLE PLASTIQUE BLEU  
60 microns

100 L



A232

SAC POUBELLE PLASTIQUE VERT  
60 microns

100 L



A233

SAC POUBELLE PLASTIQUE BLANC  
60 microns

110 L



A236

SAC POUBELLE PLASTIQUE BLEU  
70 microns

110 L



A237

SAC POUBELLE PLASTIQUE VERTS  
70 microns

110 L



A238

SAC POUBELLE PLASTIQUE JAUNE  
70 microns

110 L



A239

SAC POUBELLE PLASTIQUE BLANC  
70 microns



Photographies non contractuelles  
Reproduction interdite. © APEI 2024

# GAMME DÉCHETS



30 L



B010

SAC POUBELLE BIODÉGRADABLE  
ECONATUR  
25 microns

50 L



B013

SAC POUBELLE BIODÉGRADABLE  
ECONATUR  
35 microns

100 L



B016

SAC POUBELLE BIODÉGRADABLE  
ECONATUR  
45 microns

110 L



B019

SAC POUBELLE BIODÉGRADABLE  
ECONATUR  
50 microns

130 L



B022

SAC POUBELLE BIODÉGRADABLE  
ECONATUR  
60 microns

50 L



A244

SAC À GRAVATS PLASTIQUE  
TRANSLUCIDE  
160 microns

120 L/140 L



A202

HOUSSE CONTENEUR  
PLASTIQUE  
45 microns

240 L



A204

HOUSSE CONTENEUR  
PLASTIQUE  
45 microns

330 L/340 L



A206

HOUSSE CONTENEUR  
PLASTIQUE  
45 microns

660 L/770 L



A208

HOUSSE CONTENEUR  
PLASTIQUE  
45 microns



Photographies non contractuelles  
Reproduction interdite. © APEI 2024

# GAMME DÉCHETS



10 L



D120

**POUBELLE PLASTIQUE BLANCHE À COUVERCLE BASCULANT**  
Corps et couvercle en polypropylène blanc 95% recyclé et 100% recyclable

25 L



D125

**POUBELLE PLASTIQUE BLANCHE À COUVERCLE BASCULANT**  
Corps et couvercle en polypropylène blanc 95% recyclé et 100% recyclable

50 L



D130

**POUBELLE PLASTIQUE BLANCHE À COUVERCLE BASCULANT**  
Corps et couvercle en polypropylène blanc 95% recyclé et 100% recyclable

60 L



D135

**POUBELLE PLASTIQUE MOBILE BLANCHE À PÉDALE**  
Coloris couvercle disponibles : blanc, vert, jaune ou bleu

90 L



D140

**POUBELLE COLLECTEUR PLASTIQUE MOBILE BLANCHE À PÉDALE**  
Coloris couvercle disponibles : blanc, vert, jaune ou bleu



D145

**SUPPORT MOBILE À PÉDALE GRIS POUR SAC 110L**  
Coloris couvercle disponibles : gris, blanc, vert, jaune ou bleu

18 L



V743

**POUBELLE DE BUREAU**



# GAMME DÉCHETS



V962

**CORBILLE DE TRI SÉLECTIF**  
Carton kraft brun  
Couvercle couleurs au choix : bleu, rouge, vert ou jaune



V963

**CORBILLE DE TRI SÉLECTIF**  
Carton kraft brun - 60 L  
Couleurs panachées



V970

**COLLECTEUR DE PAPIER**  
Avec couvercle. 3 poignées. Témoin de remplissage. Intérieur et extérieur en kraft brun



F290

**CORBILLE À PAPIER**  
Carton kraft brun





# GAMME MATÉRIEL



L'Artisanerie

L'Artisanerie



L'Artisanerie

Apei  
F. ARMANI  
MUNDOCOMI

# GAMME MATÉRIEL



**G100**  
**BALAI COCO EXTRA**  
Bois poncé douille



**G120**  
**BALAI COCO EXTRA**  
Bois poncé douille

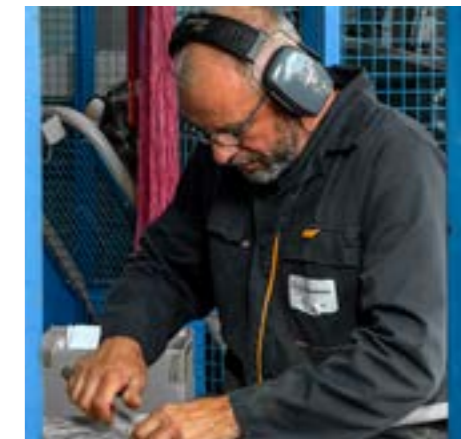

**G180**  
**BALAI DROIT CRIN MÉLANGÉ**  
Bois poncé douille



**G200**  
**BALAI MIQUET POLYPRO**  
**ONDULÉ NOIR**  
Bois laqué douille



**G210**  
**BALAI MIQUET BASSINE FORTE**  
Bois laqué douille



**G165**  
**BALAI 1/2 TÊTE SOIE NOIRE**  
Polypro verni douille  
50% soies noires / 50% PBT-PET



**G252**  
**BALAYETTE 1/2 TÊTE SOIE BLONDE**  
Manche polypropylène



**G255**  
**PELLE MÉTAL À DÉCHETS**  
**ET POUSSIÈRE**  
Métal laqué, manche bois ciré

Apei  
F. ARMANI  
MUNDOCOMI

# GAMME MATÉRIEL

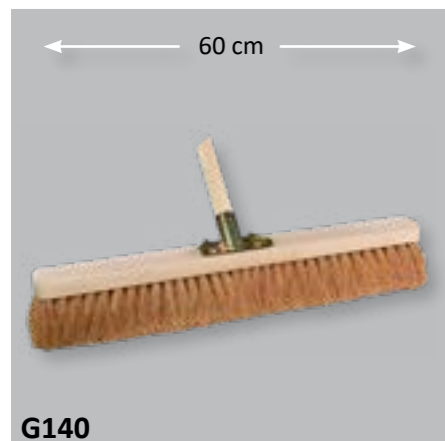

**G140**  
**BALAI COCO EXTRA**  
Emmanchure métal

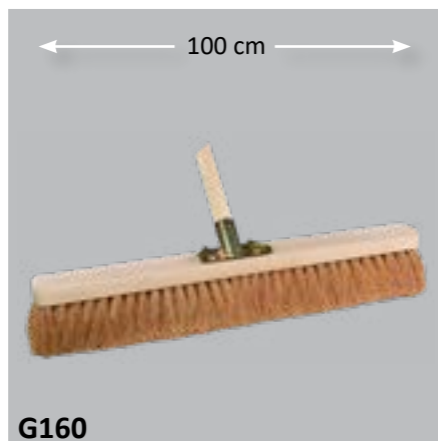

**G160**  
**BALAI COCO EXTRA**  
Emmanchure métal



**G220**  
**BALAI PVC ROUGE**  
Emmanchure métal



**G224**  
**TRIANGLE DE RENFORT ACIER**  
Pour balais 60 cm et 1 m  
Pour manches Ø 28 mm



**G402**  
**MANCHE CANTONNIER**  
Bois poncé



**G403**  
**MANCHE CANTONNIER**  
Bois poncé



# GAMME MATÉRIEL



**G190**  
**BALAI PAILLE DE RIZ 5 FILS**  
Qualité supérieure



**G230**  
**BALAI CANTONNIER PIASSAVA SUPER**  
Emmanchure métal



**G240**  
**BALAI CANTONNIER PVC CRISTAL**  
Emmanchure métal



**G242**  
**BALAI CANTONNIER GRATTOIR**  
Emmanchure métal. Fibres PBT spécial bitume. T° de fusion 250°C



**G244**  
**BALAI CANTONNIER TOUT TERRAIN**  
Support polypro, fibres PVC, douille intégrée



**G243**  
**BALAI CANTONNIER POUR BITUME**  
Emmanchure métal. Fibres PBT spécial bitume : routes, chaussées, trottoirs  
T° de fusion 250°C



# GAMME MATÉRIEL

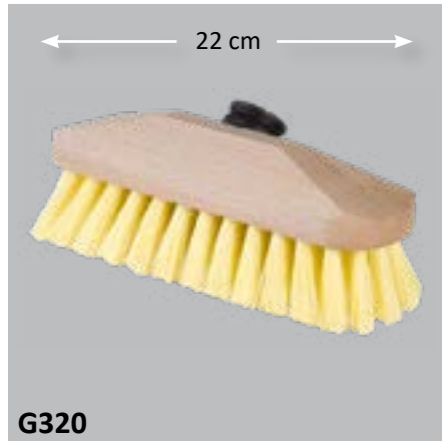

**G320**  
**LAVE PONT POLYPRO**  
Bois poncé douille



**G330**  
**FROTTOIR NYLON**  
Bois poncé douille



**G394**  
**BALAYETTE COCO EXTRA LONG**  
Bois poncé



**G404**  
**MANCHE BOIS PONCÉ**  
Embout à vis.



**G406**  
**MANCHE BOIS PONCÉ VERNIS**  
Embout à vis.

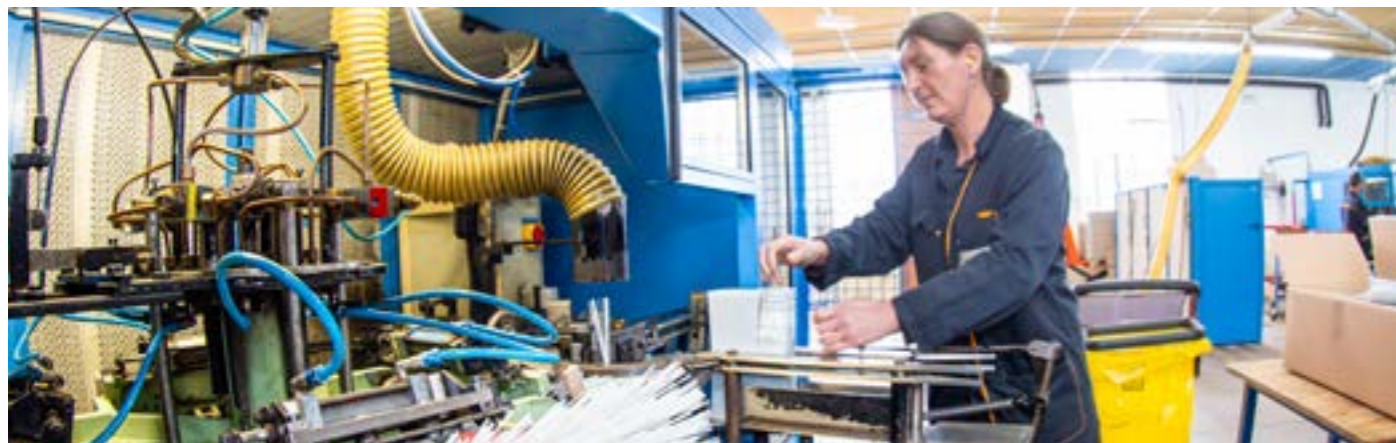

# GAMME MATÉRIEL



**G250**  
**COMBINÉ PLASTIQUE**  
**RAMASSE-POUSSIÈRE**  
Pelle et balayette

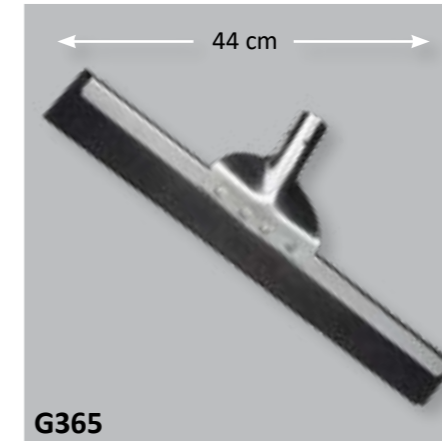

**G365**  
**RACLETTE SOL PROFESSIONNELLE**  
Double lame mousse noire  
Métal galvanisé



**G370**  
**RACLETTE SOL PROFESSIONNELLE**  
Double lame mousse noire  
Métal galvanisé



**G372**  
**RACLETTE SOL PROFESSIONNELLE**  
Double lame mousse noire  
Métal galvanisé



**G375**  
**RACLETTE SOL INDUSTRIELLE**  
Double lame mousse blanche  
Métal galvanisé



**G378**  
**RACLETTE SOL INDUSTRIELLE**  
Double lame mousse blanche  
Métal galvanisé



**G359**  
**TÊTE DE LOUP PRO**  
100% poils de chèvre

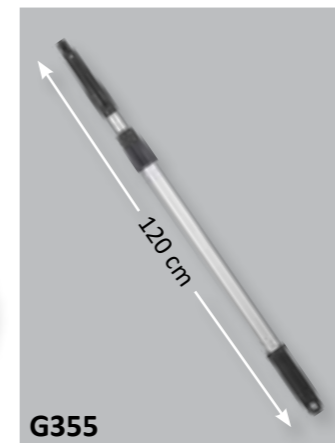

**G355**  
**PERCHE TÉLESCOPIQUE**  
**VITRES**  
Aluminium

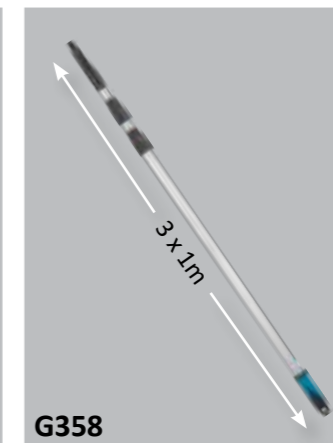

**G358**  
**PERCHE TÉLESCOPIQUE**  
Aluminium

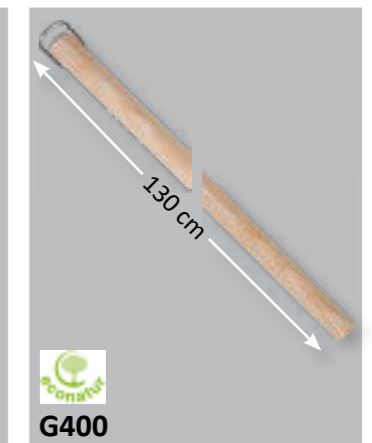

**G400**  
**MANCHE BOIS PONCÉ**

# GAMME MATÉRIEL



**A010**  
**SUPPORT LAVABLE À PLAT PLIABLE**  
 Support pliable en polypropylène  
 Rotule articulée pivotante à 360°  
 Résiste aux détergents



**A013**  
**FRANGE DE LAVAGE POUR SUPPORT PLIABLE**  
 Franges en fibres mélangées. Efficace sur tous les sols. Nettoie et absorbe



**A014**  
**FRANGE DE LAVAGE MICROFIBRE TRI COMPOSITION**  
 Pour support pliable



**A015**  
**FRANGE DE LAVAGE MICROFIBRE (MICRO ACTIVA)**  
 Pour support pliable



**A024**  
**SUPPORT LAVAGE À PLAT VELCRO AVEC FIXE GAZES**  
 Aluminium anodisé (antirouille) et plastique (polyamide)



**A023**  
**GAZE DÉPOUSSIÉRANTE ÉLECTROSTATIQUE À USAGE UNIQUE**  
 Fibres non tissées



**A025**  
**FRANGE DE LAVAGE MICROFIBRE BLEUE**  
 Pour support velcro



**A046**  
**MANCHE ALUMINIUM ANODISÉ**  
 Ø 23 mm



Photographies non contractuelles  
 Reproduction interdite. © APEI 2024

# GAMME MATÉRIEL



**A028**  
**SEAU DE LAVAGE BI-BAC 2 x 8 L**  
 Avec rouleaux essoreurs à pédale intégrée.  
 Seau à double compartiment



**A029**  
**SEAU DE LAVAGE BI-BAC 2 x 8 L À ROULETTES.** Avec rouleaux essoreurs à pédale intégrée.  
 Seau double compartiment



**A032**  
**SEAU ROND PROFESSIONNEL BLEU**  
 Polyéthylène basse densité  
 Fond renforcé



**A043**  
**PANNEAU D'AVERTISSEMENT JAUNE "SOL GLISSANT"**  
 En polypropylène  
 Pliable



**A048**  
**SEAU DE LAVAGE DOUBLE BAC**  
 Bac 8 L - Bac 6 L  
 Copolymère de polypropylène  
 Avec essoreur amovible



**A050**  
**FRANGE COTON BALAI LAVEUR ESPAGNOL**  
 Fils fins 100% coton. Lavage maxi 50°C  
 Haute qualité - Ne peluche pas

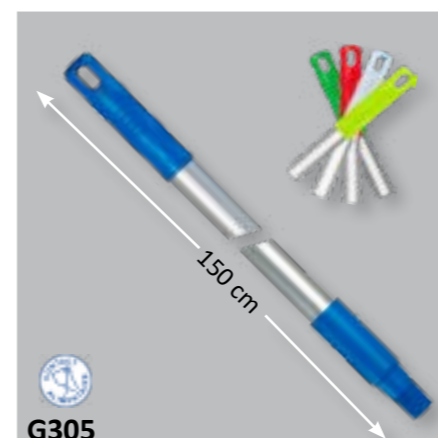

**G305**  
**MANCHE ALUMINIUM ANODISÉ**  
 Pour brosse et raclettes alimentaires  
 Coloris possibles manchons : jaune, rouge, blanc ou vert



Photographies non contractuelles  
 Reproduction interdite. © APEI 2024

# GAMME MATÉRIEL



# GAMME MATÉRIEL

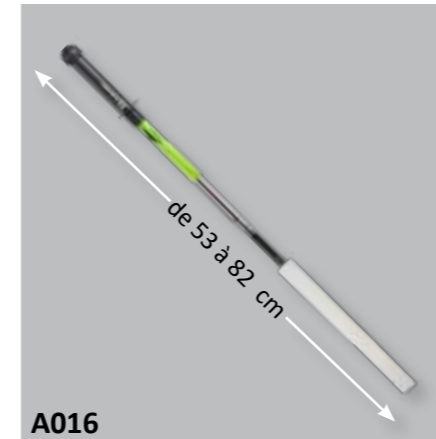

**A016**  
**NET SYSTÈME DÉPOUSSIÉRANT**  
Outil à mémoire de forme multidirectionnel ultra flexible avec manche télescopique

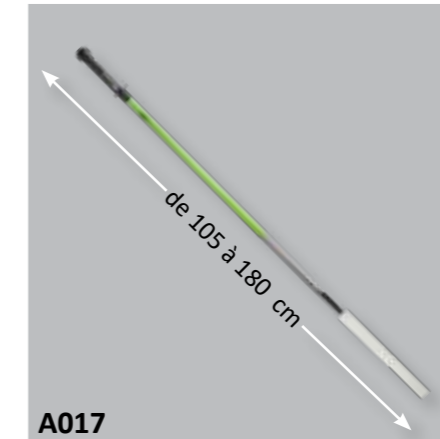

**A017**  
**NET SYSTÈME DÉPOUSSIÉRANT**  
Outil à mémoire de forme multidirectionnel ultra flexible avec manche télescopique

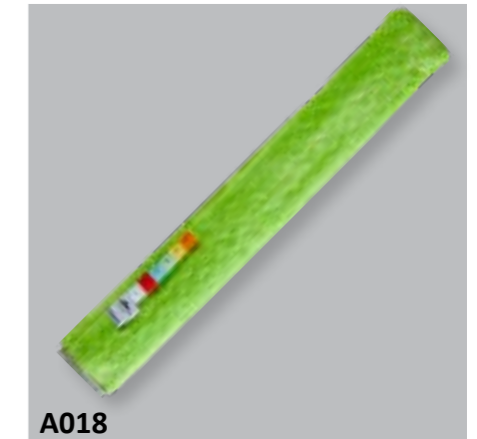

**A018**  
**HOUSSE MICROFIBRE POUR NET SYSTÈME DÉPOUSSIÉRANT**  
Haute qualité d'essuyage Absorbe et retient les micro-particules



**A020**  
**GANT MICROFIBRE DE DÉPOUSSIÉRAGE ET DE NETTOYAGE**  
Pour le nettoyage et le dépeussierage de toutes les surfaces



**A022**  
**GANT MICROFIBRE SPÉCIAL VITRES**  
Nettoyage et dégraissage des vitres, miroirs et toutes surfaces lisses



**A038**  
**COMBINÉ PELLE-BALAI À DÉCHETS**  
Manche télescopique en aluminium et pelle en polypropylène

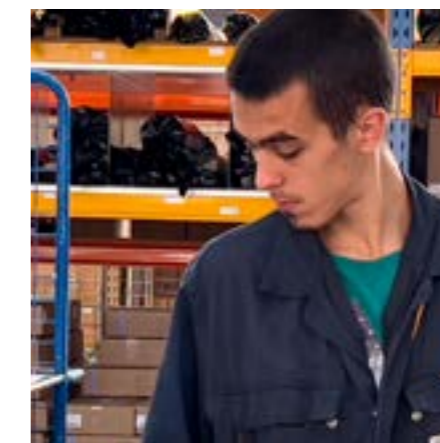

# GAMME MATÉRIEL



**G611**  
**BÊCHE À REBORDS 28 CM**  
 Manche composite Novagrip 1 m  
 Acier au bore micro-allié  
 entièrement trempé



**G619**  
**FOURCHE À FUMIER À DOUILLE 4 DENTS**  
 Manche bois cintré ciré 1,30 m  
 Acier au carbone. Dents trempées



**G620**  
**RATEAU FORGÉ 16 DENTS COURBÉES 46 CM.** Manche bois frêne poncé ciré 1,50 m. Douille forgée. Dents acier entièrement trempé



**G621**  
**RATEAU FORGÉ 14 DENTS DROITES 40 CM**  
 Manche bois frêne poncé ciré 1,50 m. Douille forgée



**G622**  
**BALAI À GAZON POLYMÈRE**  
 27 dents fil plat 65 cm  
 Manche bois 1,50 m



**G623**  
**BALAI À GAZON**  
 20 dents fil rond 50 cm  
 Manche bois 1,50 m



**G624**  
**PINCE À DÉCHETS**  
 Longueur : 105 cm. Aluminium  
 Polyvalente ergonomique  
 Poignée gachette

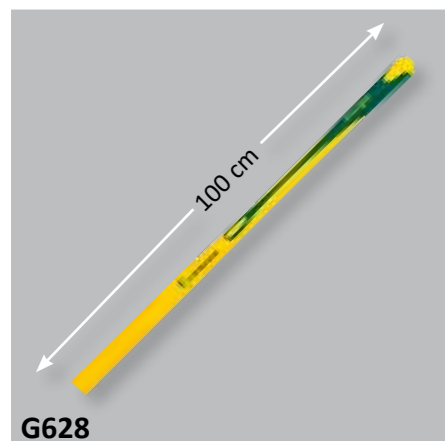

**G628**  
**MANCHE NOVAGRIP**  
 Pour bêches à rebords 28 cm



**G680**  
**BINETTE FORGÉE AVEC MANCHE BOIS FRÊNE PONCÉ 1,30M**  
 Monture entièrement forgée  
 Lame rivetée



**G682**  
**BINETTE TRIANGULAIRE FORGÉE AVEC MANCHE BOIS FRÊNE PONCÉ 1,30 M.** Acier au carbone  
 Lame acier biseauté rivetée



Photographies non contractuelles  
 Reproduction interdite. © APEI 2024

# GAMME MATÉRIEL



**G600**  
**PELLE RONDE COL DE CYGNE 27 CM**  
 Manche bois frêne poncé ciré 1,10 m  
 Acier au bore micro-allié  
 entièrement trempé



**G603**  
**PELLE CARRÉE COL DE CYGNE 25 CM**  
 Manche bois frêne poncé ciré 1,10 m  
 Acier au bore micro-allié  
 entièrement trempé



**G604**  
**POUSSOIR POLYPROPYLENE VERT**  
 66 cm avec lamelle d'usure en acier galvanisé. Manche droit en bois dur verni 117 cm. Poignée plastique



**G605**  
**POUSSOIR POLYMÈRE VERT**  
 Pour neige et grains spécial grande surface 65 cm. Manche bois à poignée plastique 130 cm



**G606**  
**PELLE ALUMINIUM EXTRA CREUSE**  
 Manche bois frêne poncé ciré 1,20 m  
 Aluminium épaisseur 2,5 mm  
 Extra creuse, robuste, légère, maniable



**G607**  
**PELLE ABS EXTRA CREUSE**  
 Manche bois frêne poncé ciré 1,20 m  
 ABS résine certifiée qualité alimentaire  
 Extra creuse, robuste, légère



**G686**  
**RACLOIR DE COFFREUR**  
 Lame en acier boulonnée avec  
 manche en bois frêne poncé ciré 1,20 m



Photographies non contractuelles  
 Reproduction interdite. © APEI 2024

# GAMME MATÉRIEL



G609

**PELLE ALUMINIUM AUTO**  
Manche bois frêne poncé ciré 1,20 m  
Aluminium ép. 2 mm. Robuste, légère,  
maniable, peu encombrante



G618

**PIOCHE TERRASSIER CÊIL ROND**  
Manche composite NOVAGRIP 0,90 m  
Acier au carbone forgé  
Pointe et panne trempées

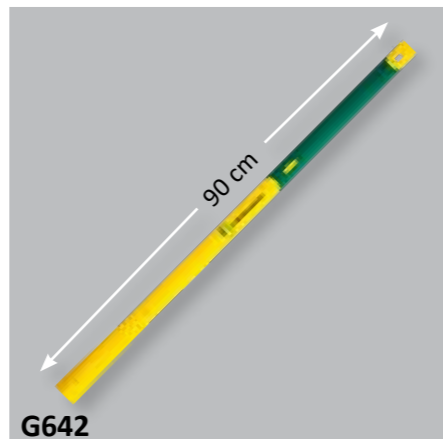

G642

**MANCHE COMPOSITE NOVAGRIP**  
Ø 48 mm  
Pour pioche terrassier



G633

**MANCHE BOIS FRÊNE PONCÉ CIRÉ.**  
Ø 40 mm. Pour pelles alu extra creuse  
ou alu auto



G635

**MANCHE BOIS FRÊNE PONCÉ CIRÉ.**  
Ø 40 mm. Pour pelles ABS extra creuse



G630

**MANCHE BOIS FRÊNE PONCÉ CIRÉ.**  
Ø 40 mm  
Pour pelles col de cygne



G645

**MANCHE BOIS FRÊNE PONCÉ CIRÉ.**  
Ø 28 mm  
Pour râteau forgé et balai bouleau polypro



# GAMME MATÉRIEL



G647

**CISEAUX UNIVERSELS**  
Lames en acier inoxydable  
adaptées au contact alimentaire  
Anneaux ergonomiques



G649

**SÉCATEUR JARDIN EXPERT**  
Poignées ergonomiques anti-glisse  
en polypropylène. Lames acier  
inoxydable. Ø de coupe 26 mm



G651

**CISAILLE À HAIES PRO**  
Poignées polyamide et fibre de verre  
Lames acier inoxydable  
Double cremaillère

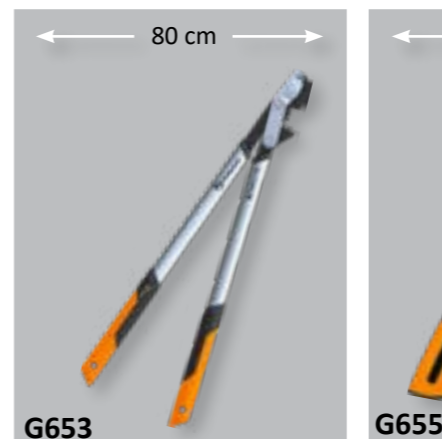

G653

**COUPE BRANCHES**  
**ÉLAGUEUR PRO**  
Lames en acier inoxydable  
Ø de coupe 55 mm



G655

**SCIE DE JARDIN EXPERT**  
**LAME RÉTRACTABLE**  
Manche softgrip polyamide  
et fibre de verre

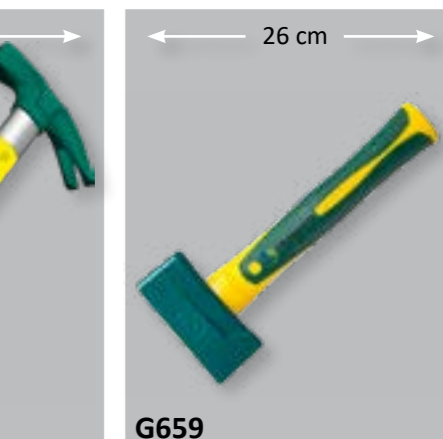

G657

**MARTEAU COFFREUR**  
**BATIPRO MANCHE NOVAMAX**  
Acier au carbone  
forgé et trempé

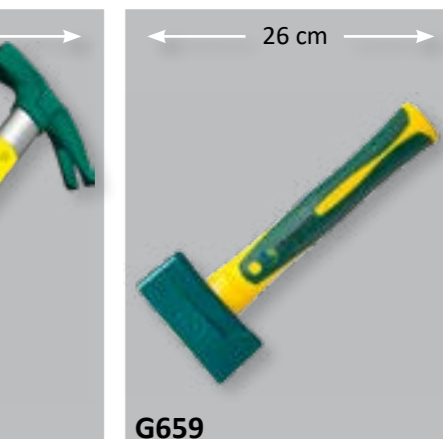

G659

**MASSETTE PRO MANCHE**  
**NOVAMAX** Outil forgé et  
trempé, très résistant à l'usure  
Poignée ergonomique



G660

**SEAU DE MAÇON**  
**PLASTOGOM NOIR**  
Caoutchouc synthétique

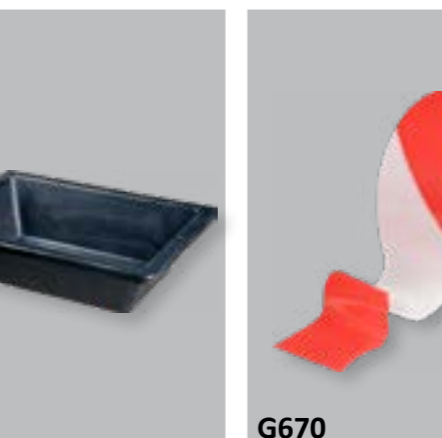

G662

**AUGE PLASTOGOM NOIRE**  
Caoutchouc synthétique

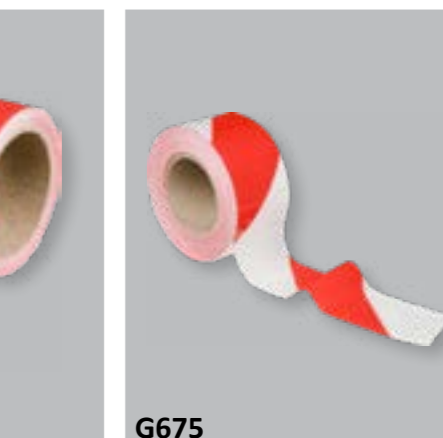

G670

**RUBAN DE SIGNALISATION**  
**EXTRA**  
Rouleau de 100 m x 50 mm

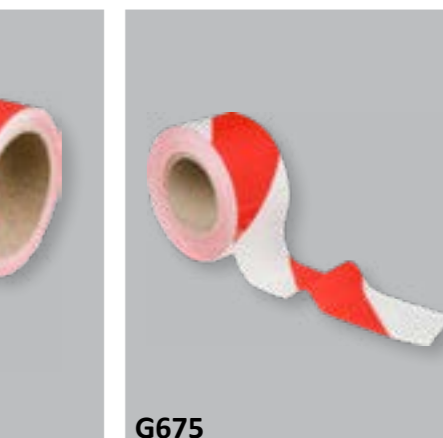

G675

**RUBAN DE SIGNALISATION**  
**EXTRA**  
Rouleau de 300 m x 70 mm

# GAMME MATÉRIEL



**G482**  
**PINCEAU PRO PRESTIGE**  
**SOIE EXTRA 20MM**  
 Virole laitonée  
 Manche bois teinté chêne



**G483**  
**PINCEAU PRO PRESTIGE**  
**SOIE EXTRA 30MM**  
 Virole laitonée  
 Manche bois teinté chêne



**G484**  
**PINCEAU PRO PRESTIGE**  
**SOIE EXTRA 40MM**  
 Virole laitonée  
 Manche bois teinté chêne



**G485**  
**PINCEAU PRO PRESTIGE**  
**SOIE EXTRA 50MM**  
 Virole laitonée  
 Manche bois teinté chêne



**G486**  
**PINCEAU PRO PRESTIGE**  
**SOIE EXTRA 60MM**  
 Virole laitonée  
 Manche bois teinté chêne



**G593**  
**PINCEAU PRO PRESTIGE**  
**SOIE EXTRA**  
 Tailles panachées :  
 20, 30, 40, 50 et 60 mm



**G494**  
**BROSSE À RECHAMPIR PRO**  
**PRESTIGE**  
**SOIE EXTRA N°3/0 - 15 MM**  
 Virole inox



**G495**  
**BROSSE À RECHAMPIR PRO**  
**PRESTIGE**  
**SOIE EXTRA N°0 - 18 MM**  
 Virole inox



**G496**  
**BROSSE À RECHAMPIR PRO**  
**PRESTIGE**  
**SOIE EXTRA N°2 - 21 MM**  
 Virole inox



**G497**  
**BROSSE À RECHAMPIR PRO**  
**PRESTIGE**  
**SOIE EXTRA N°4 - 25 MM**  
 Virole inox



**G599**  
**BROSSE À RECHAMPIR PRO**  
**PRESTIGE SOIE EXTRA**  
 Tailles panachées : n°3/0-15mm  
 n°0-18 mm, n°2-21 mm, n°4-25 mm



Photographies non contractuelles  
 Reproduction interdite. © APEI 2024

# GAMME MATÉRIEL



**G491**  
**BROSSE POUCE PRO**  
**PRESTIGE**  
**SOIE EXTRA N°2 - 21 MM**  
 Virole inox



**G492**  
**BROSSE POUCE PRO**  
**PRESTIGE**  
**SOIE EXTRA N°4 - 25 MM**  
 Virole inox



**G493**  
**BROSSE POUCE PRO**  
**PRESTIGE**  
**SOIE EXTRA N°6 - 29 MM**  
 Virole inox



**G596**  
**BROSSE POUCE PRO**  
**PRESTIGE SOIE EXTRA**  
 Tailles panachées : n°2-21 mm,  
 n°4-25 mm, n°6-29mm



**G489**  
**BROSSE POUCE EXTRA POLYAMIDE**  
**CRISTAL N°4 - 25 MM**  
 Virole acier cuivré  
 Manche bois naturel



**G410**  
**PINCEAU POLYAMIDE CRISTAL**  
**30 MM**  
 Virole fer poli  
 Manche polypro beige



**G420**  
**PINCEAU POLYAMIDE CRISTAL**  
**40 MM**  
 Virole fer poli  
 Manche polypro beige



**G557**  
**BROSSE RADIATEUR SOIE**  
**EXTRA 30 MM**  
 Virole acier cuivré coudé sur plat  
 Manche bois naturel



**G558**  
**BROSSE RADIATEUR SOIE**  
**EXTRA 40 MM**  
 Virole acier cuivré coudé sur plat  
 Manche bois naturel



Photographies non contractuelles  
 Reproduction interdite. © APEI 2024



# GAMME LOCAUX



L'Artisanerie



L'Artisanerie



Foyers  
Ariana-FAGOT

Apei  
F. ARMANI  
MONTICELLI

# GAMME LOCAUX



**G350**  
**GRATTOIR VITRES PRO**  
**AVEC POIGNÉE BI-MATIÈRE**  
Largeur de lame 10 cm



**G351**  
**DISTRIBUTEUR LAMES**  
**DE RECHANGE**  
25 lames - 10 cm



**G352**  
**GRATTOIR VITRES**  
**DE POCHE**  
Largeur de lame 4 cm



**G353**  
**DISTRIBUTEUR LAMES**  
**DE RECHANGE**  
5 lames - 4 cm



**G361**  
**RACLETTE VITRE INOX PRO**  
Nettoyage des vitres ou des surfaces  
planes + 1 lame de rechange



**G362**  
**LAME CAOUTCHOUC DE RECHANGE**  
35 cm



**G355**  
**PERCHE TÉLESCOPIQUE VITRES**  
Aluminium



**G356**  
**SUPPORT MOUILLEUR VITRES PRO**  
Housse microfibre



**G357**  
**HOUSSE DE MOUILLEUR**  
**VITRES PRO MICROFIBRE**  
35 cm

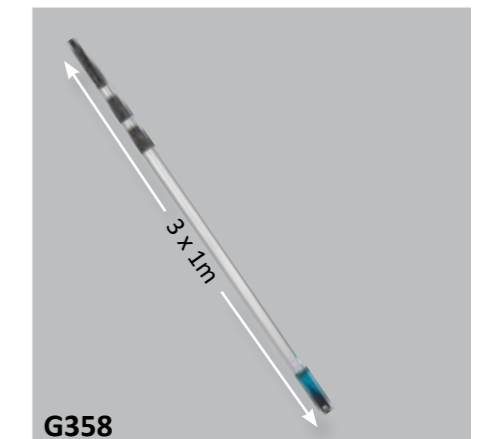

**G358**  
**PERCHE TÉLESCOPIQUE**  
Aluminium

Apei  
F. ARMANI  
MONTICELLI

# GAMME LOCAUX

TAPIS D'INTÉRIEUR ANTI-POUSSIÈRE ABSORBANT



**A053/A053 1** GRAND TRAFIC

**FEUILLES - JAUNE**  
A053 : 90 x 120 cm  
A053 1 : 60 x 90 cm



**A054/A054 1** GRAND TRAFIC

**CARRÉS - BLEU**  
A054 : 90 x 120 cm  
A054 1 : 60 x 90 cm



**A055 A055 1** GRAND TRAFIC

**BANDES - NOIR**  
A055 : 90 x 120 cm  
A055 1 : 60 x 90 cm

Œuvre réalisée par des adultes handicapés à l'atelier de pratiques artistiques de l'APEI de Saint-Amand-Montrond sous la direction de Ludivine Barbault

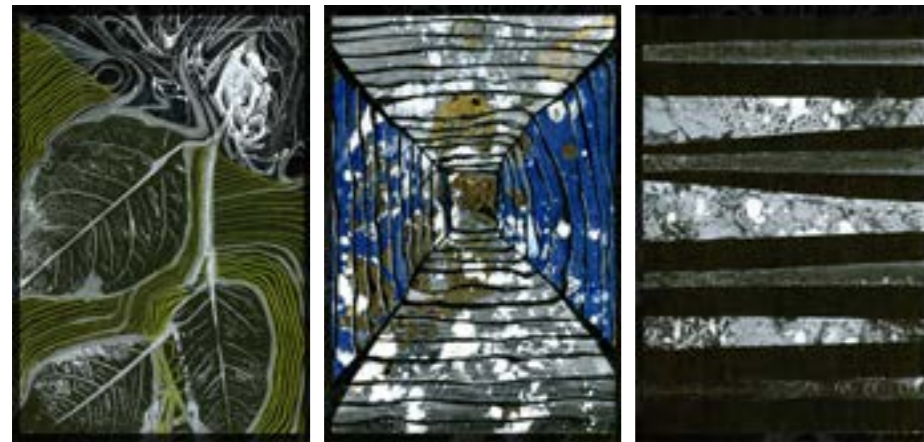

**SUR COMMANDE SPÉCIALE** - Délai 8 semaines  
90 x 150 cm - 120 x 180 cm - 120 x 240 cm

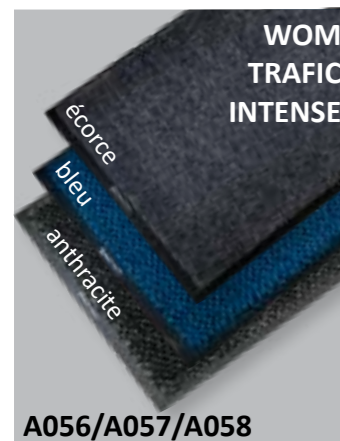

**A056/A057/A058**

Couleur au choix  
A056 : 60 x 85 cm  
A057 : 85 x 150 cm  
A058 : 115 x 180 cm (anthracite ou écorce)

**SUR COMMANDE SPÉCIALE**  
Délai 8 semaines

**MODÈLE WOM**  
Au choix :  
Anthracite / écorce

Existe en :  
115 x 240 cm  
150 x 250 cm  
200 x 200 cm  
200 x 300 cm



**A067/A068/A069**

Couleur au choix  
A067 : 60 x 85 cm  
A068 : 85 x 150 cm  
A069 : 115 x 180 cm

**SUR COMMANDE SPÉCIALE**  
Délai 8 semaines

**MODÈLE SYMPHONIE**  
Au choix :  
Anthracite / bleu / rouge

Existe en :  
115 x 240 cm  
150 x 250 cm  
200 x 200 cm  
200 x 300 cm

# GAMME LOCAUX



**A093**

**TAPIS BROSE QUALITÉ SUPÉRIEURE**  
Pur coco naturel  
40 x 80 cm



**A095**

**TAPIS BROSE QUALITÉ SUPÉRIEURE**  
Pur coco naturel  
50 x 100 cm



**A097**

**TAPIS BROSE QUALITÉ SUPÉRIEURE**  
Pur coco naturel  
60 x 120 cm



**TDS**

**TAPIS BROSE DENSITÉ PMR\*\***  
Pur coco naturel  
Découpe personnalisée

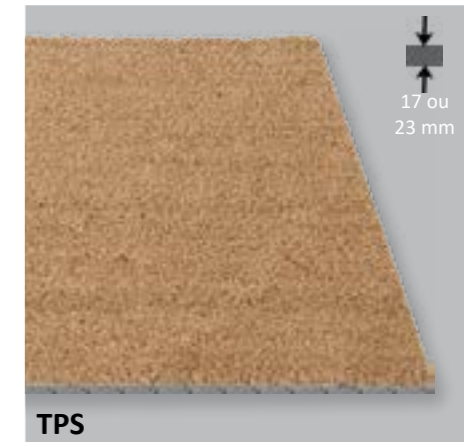

**TPS**

**TAPIS BROSE**  
Pur coco naturel  
Découpe personnalisée



**A894**

**INSECTICIDE SPÉCIAL GUÊPES ET FRELONS** Traitement des nids  
Action immédiate - Effet foudroyant  
Diffuseur gros débit - Jet 4m



**A455**

**ARTISOL, ABSORBANT MINÉRAL INDUSTRIEL 30 L**  
Nettoyant et antidérapant  
Absorbant industriel et routier



Photographies non contractuelles  
Reproduction interdite. © APEI 2024



Photographies non contractuelles  
Reproduction interdite. © APEI 2024

\*Établissements Recevant du Public  
\*\*Personne à Mobilité Réduite

# GAMME LOCAUX

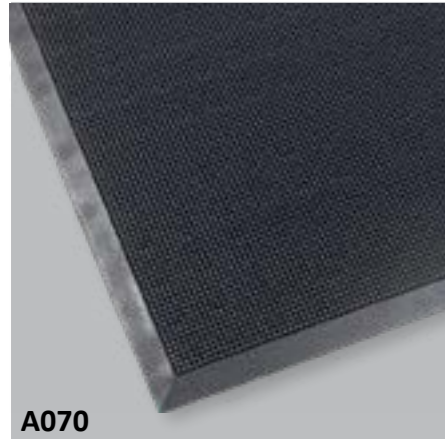

**A070**  
**TAPIS CAOUTCHOUC NATUREL**  
 Noir avec picots brush  
 60 x 80 cm

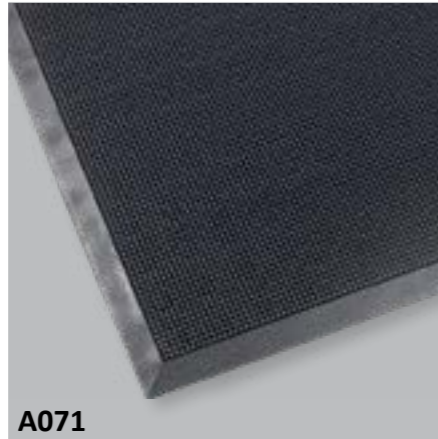

**A071**  
**TAPIS CAOUTCHOUC NATUREL**  
 Noir avec picots brush  
 80 x 100 cm

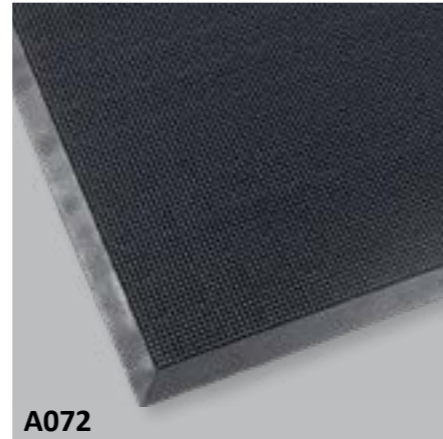

**A072**  
**TAPIS CAOUTCHOUC NATUREL\***  
 Noir avec picots brush  
 90 x 150 cm

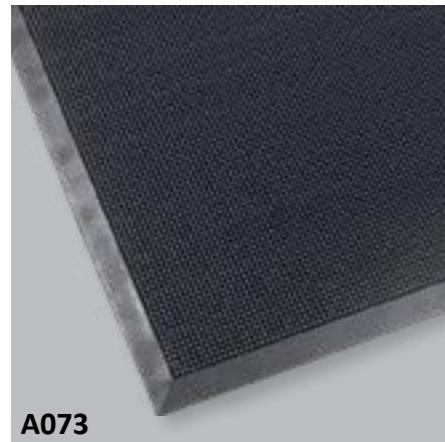

**A073**  
**TAPIS CAOUTCHOUC NATUREL\***  
 Noir avec picots brush  
 90 x 180 cm

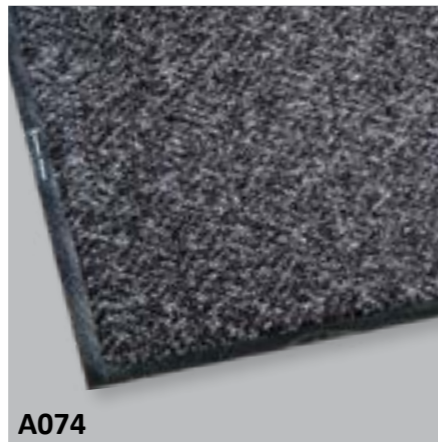

**A074**  
**TAPIS GRATTANT D'EXTÉRIEUR**  
 Gris. 100% fibres polyamide 6  
 régénérées ECONYL®  
 60 x 85 cm



**A075**  
**TAPIS CAOUTCHOUC NATUREL**  
 Gris. 100% fibres polyamide 6  
 régénérées ECONYL®  
 85 x 150 cm

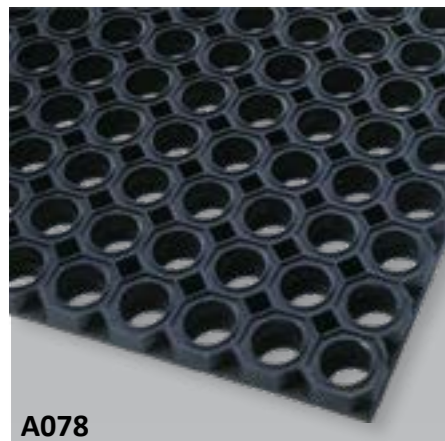

**A078**  
**TAPIS CAILLEBOTIS OMAT**  
 Noir standard. Extérieur  
 Caoutchouc naturel  
 75 x 100 cm

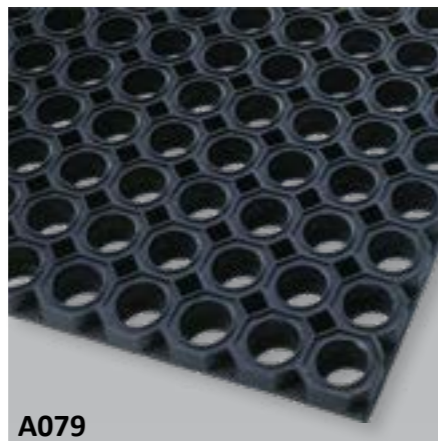

**A079**  
**TAPIS CAILLEBOTIS OMAT**  
 Noir standard. Extérieur  
 Caoutchouc naturel  
 100 x 150 cm

\*Exclusivement sur commande spéciale



Photographies non contractuelles  
 Reproduction interdite. © APEI 2024

# GAMME LOCAUX

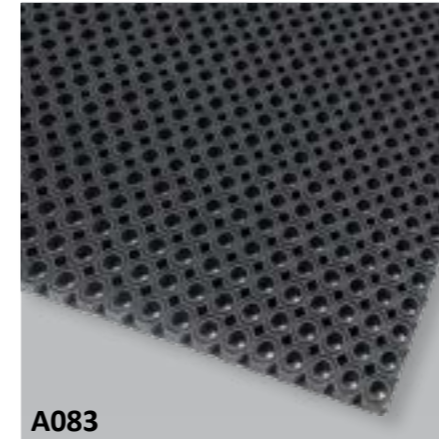

**A083**  
**TAPIS CAILLEBOTIS TOFLEX**  
 Noir. Petits trous - Accès faciles  
 Caoutchouc naturel  
 75 x 100 cm

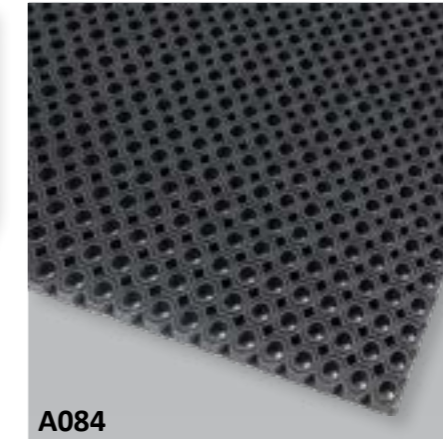

**A084**  
**TAPIS CAILLEBOTIS TOFLEX**  
 Noir. Petits trous - Accès faciles  
 Caoutchouc naturel  
 100 x 150 cm

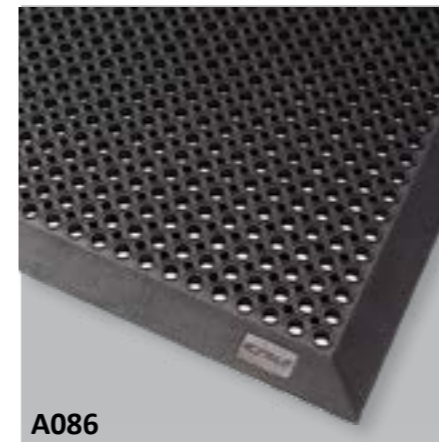

**A086**  
**TAPIS CAILLEBOTIS BORDÉ TOFLEX-B**  
 Noir. Petits trous - Accès faciles  
 Caoutchouc naturel  
 70 x 90 cm

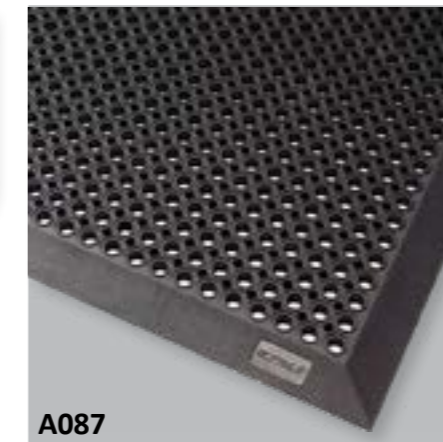

**A087**  
**TAPIS CAILLEBOTIS BORDÉ TOFLEX-B**  
 Noir. Petits trous - Accès faciles  
 Caoutchouc naturel  
 90 x 150 cm

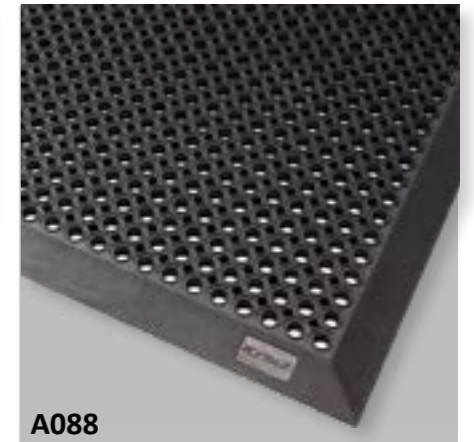

**A088**  
**TAPIS CAILLEBOTIS BORDÉ TOFLEX-B\***  
 Noir. Petits trous - Accès faciles  
 Caoutchouc naturel  
 120 x 180 cm

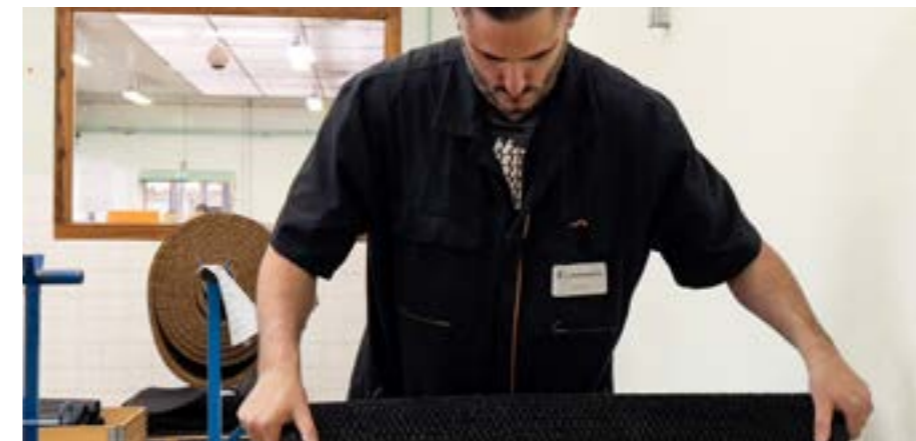

\*Exclusivement sur commande spéciale



Photographies non contractuelles  
 Reproduction interdite. © APEI 2024

# GAMME TEXTILE



L'Artisanerie



L'Artisanerie



L'Artisanerie



Photographies non contractuelles  
Reproduction interdite. © APEI 2024

# GAMME TEXTILE



**A100**  
**SERPILLIÈRE GAUFRÉE SUPER**  
**EXTRA BLANCHE**  
60 x 100 cm



**A101**  
**SERPILLIÈRE BOUCLÉE**  
**TISSÉPONGE**  
45 x 70 cm



**A105**  
**LAVETTE GAUFRÉE BLANCHE**  
**NID D'ABEILLE**  
35 x 65 cm



**A115**  
**LAVETTE NON TISSÉE UNIVERSELLE**  
**MULTI-SURFACES.** 4 couleurs panachées  
bleu, jaune, rose et vert. Lavable en  
machine à 90°C. 35 x 50 cm



**A117**  
**LAVETTE NON TISSÉE UNIVERSELLE**  
**MULTI-SURFACES.** 4 couleurs au choix  
bleu, jaune, rose ou vert. Lavable en  
machine à 90°C. 35 x 50 cm



**A138**  
**PEAU CHAMOISÉE ENTIÈRE**  
Qualité PRO. Peau de mouton  
Tannage 100% huile de poisson  
52 x 77 cm



Photographies non contractuelles  
Reproduction interdite. © APEI 2024

# GAMME TEXTILE



**A103**  
**SERPILLIÈRE MICROFIBRE SOLNETT**  
3 couleurs au choix : bleu, vert ou rose. 60 x 70 cm



**A104**  
**SERPILLIÈRE MICROFIBRE SOLNETT**  
3 couleurs panachées : bleu, vert et rose. 60 x 70 cm



**A106**  
**SERPILLIÈRE MICROFIBRE SUPERNETT MULTI-USAGES**  
4 couleurs panachées : bleu, jaune, rose et vert. 40 x 40 cm



**A107**  
**SERPILLIÈRE MICROFIBRE SUPERNETT MULTI-USAGES**  
4 couleurs au choix : bleu, jaune, rose ou vert. 40 x 40 cm



**A108**  
**LAVETTE MICROFIBRE ULTRANETT HAUTE PERFORMANCE BLEUE**  
40 x 40 cm



**A110** Face absorbante  
**CARRÉ MICROFIBRE BI-TEXTURE GRIS**  
28 x 28 cm



**A112** Face absorbante  
**ÉPONGE MICROFIBRE BI-TEXTURE GRISE**  
130 x 90 x 25 mm



**A113** Essuie  
**ÉPONGE MICROFIBRE BI-TEXTURE BLEUE**  
140 x 90 x 30 mm



**A121** Face grattante  
**CARRÉ MICROFIBRE BI-MATIÈRE BLEU ET ROUGE**  
30 x 30 cm



**A122** Face absorbante  
**TAMPON MICROFIBRE BI-MATIÈRE VERT**  
20 x 14 cm



**A124**  
**LAVETTE MICROFIBRE POLISH GRISE**  
40 x 40 cm



**A126**  
**LAVETTE MICROFIBRE VAGUE**  
36 x 36 cm

# GAMME TEXTILE



**A564**  
**CHIFFON TEXTILE TISSÉ BLANC OPTIQUE EXTRA.** Coupe formatée  
Drap blanc coton extra fin sans couture



**A566**  
**CHIFFON TEXTILE TISSÉ BLANC OPTIQUE EXTRA.** Coupe formatée  
Drap blanc coton extra fin sans couture



**A574**  
**CHIFFON TEXTILE JERSEY COULEUR**  
Polo et tee-shirt couleur coton fin



**A576**  
**CHIFFON TEXTILE JERSEY COULEUR**  
Polo et tee-shirt couleur coton fin



**A578**  
**CHIFFON BLANC NON TISSÉ ULTRA RÉSISTANT**  
Boîte distributrice de 120 formats



**A600**  
**CHIFFON BLANC NON TISSÉ POLYVALENT HAUTE PERFORMANCE**  
Essuyeur haute performance multi-usages. Très absorbant



**A119**  
**BOBINE D'ESSUYAGE MICROFIBRE**  
Gris. 80% polyester et 20% polyamide  
75 formats 30 x 30 cm prédécoupés



# GAMME TEXTILE

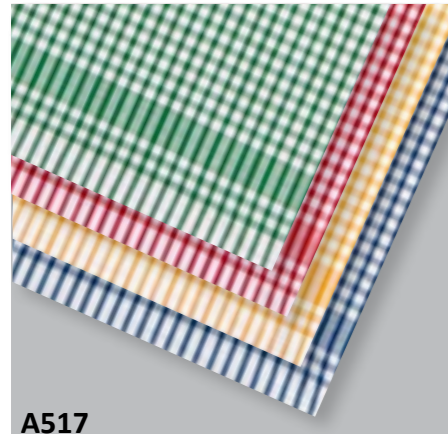

A517

**TORCHON CUISINE OFFICE TISSÉ CARREAUX**

Au choix : bleu, rouge, jaune ou vert  
50 X 82 cm - 100% coton - 260 g/m<sup>2</sup>

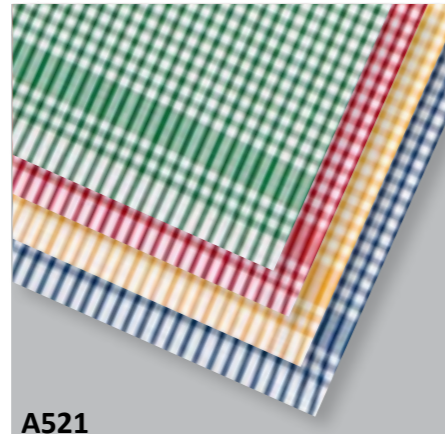

A521

**TORCHON CUISINE OFFICE TISSÉ CARREAUX**

Panaché : bleu, rouge, jaune et vert  
50 X 82 cm - 100% coton - 260 g/m<sup>2</sup>



A526

**TORCHON ESSUIE VERRES MICROFIBRE GRIS**

50 X 70 cm - 70% polyester  
30% polyamide - 220 g/m<sup>2</sup>



A527

**TORCHON ESSUIE VERRES MICROFIBRE BLANC**

50 X 70 cm - 70% polyester  
30% polyamide - 220 g/m<sup>2</sup>



A528

**TORCHON ESSUIE VERRES MICROFIBRE GRIS**

40 X 75 cm - 70% polyester  
30% polyamide - 230 g/m<sup>2</sup>

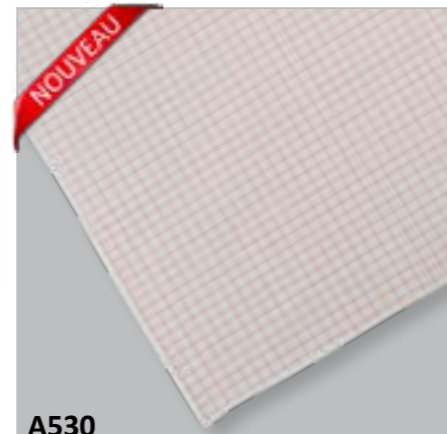

A530

**TORCHON MICROFIBRE CARREAUX ROUGE**

50 X 70 cm - 80% polyester  
20% polyamide - 360 g/m<sup>2</sup>



A466

**TORCHON ESSUIES-MAINS ESSUIE-TOUT NID D'ABEILLES**

52 X 82 cm - 100% coton - 260 g/m<sup>2</sup>



A491

**SERVIETTE ESSUIES-MAINS ÉPONGE BLEU**

50 X 90 cm - 100% coton - 400 g/m<sup>2</sup>



A493

**SERVIETTE ESSUIE-MAINS ÉPONGE JACQUARD ATELIER**

50 X 90 cm - 100% coton - 350 g/m<sup>2</sup>



Photographies non contractuelles  
Reproduction interdite. © APEI 2024

# GAMME TEXTILE

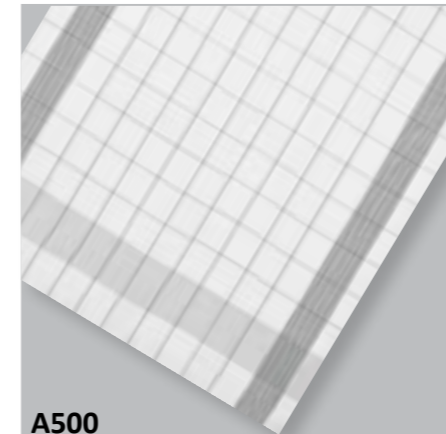

A500

**TORCHON MÉTIS CARREAUX GRIS**

60 x 78 cm - 50% coton - 50% lin  
220 g/m<sup>2</sup>

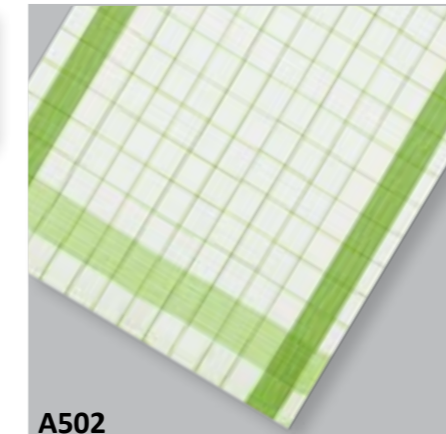

A502

**TORCHON MÉTIS CARREAUX VERT**

60 x 78 cm - 50% coton - 50% lin  
220 g/m<sup>2</sup>

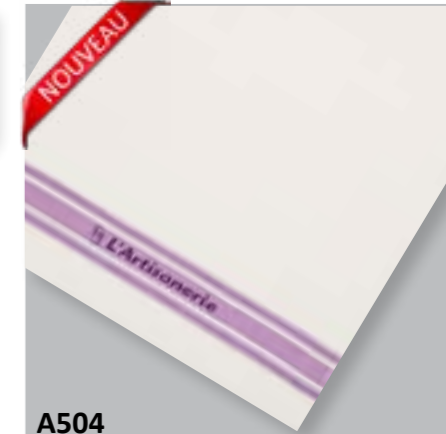

A504

**TORCHON MÉTIS ARTI FUSCHIA**

60 x 78 cm - 50% coton - 50% lin  
220 g/m<sup>2</sup>

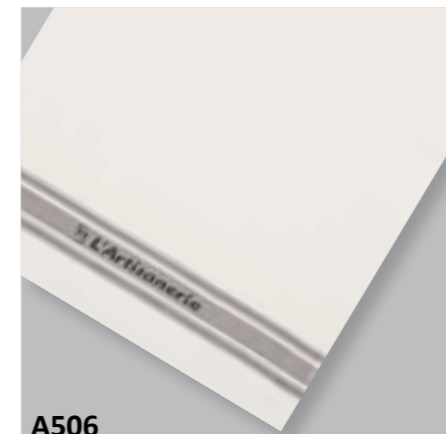

A506

**TORCHON MÉTIS ARTI CHATAIGNE**

60 x 78 cm - 50% coton - 50% lin  
220 g/m<sup>2</sup>

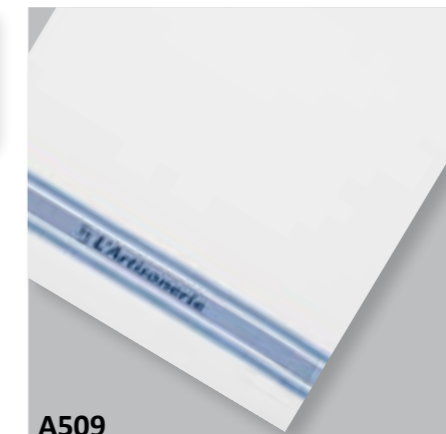

A509

**TORCHON MÉTIS ARTI BLEU**

60 x 78 cm - 100% coton  
220 g/m<sup>2</sup>

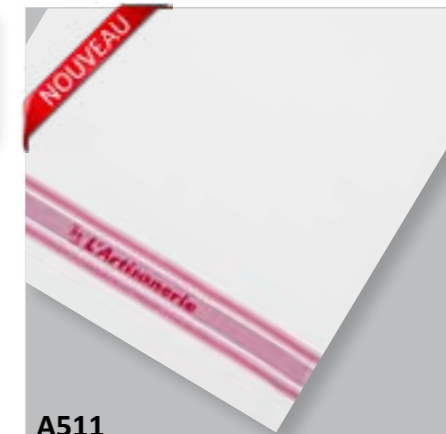

A511

**TORCHON MÉTIS ARTI ROUGE**

60 x 78 cm - 100% coton  
220 g/m<sup>2</sup>



Photographies non contractuelles  
Reproduction interdite. © APEI 2024

# GAMME TEXTILE



**T100**

**TABLIER À BAVETTE BLANC**  
100% PVC - 70 x 100 cm - 450 g/m<sup>2</sup>  
Toile caoutchoutée traitée :  
anti-gras, anti-lactique



**T110**

**TABLIER À BAVETTE BLANC**  
100% PVC - 90 x 115 cm - 450 g/m<sup>2</sup>  
Toile caoutchoutée traitée :  
anti-gras, anti-lactique



**T115**

**TABLIER À BAVETTE BLANC TOILE  
CAOUTCHOUTÉE.** 90 x 115 cm  
80% Nitrile, 20% Polyester - 600 g/m<sup>2</sup>  
Toile traitée : anti-gras, anti-lactique



**T130**

**TABLIER À BAVETTE BLANC**  
85 x 100 cm - 100% Coton  
250 g/m<sup>2</sup>



**T135**

**TABLIER À BAVETTE BLEU**  
85 x 100 cm - 100% Coton  
250 g/m<sup>2</sup>



**T140**

**TABLIER SANS BAVETTE BLANC**  
90 x 70 cm - 100% Coton  
250 g/m<sup>2</sup>



**T234**

**BAVOIR ENFANT ÉPONGE "TEDDY"**  
50 x 35 cm - 100% coton - 400 g/m<sup>2</sup>



**T526 (coloris oxyde)**

**VALISSETTE LINGE ÉPONGE**  
Pur coton peigné 600 g/m<sup>2</sup>  
1 drap de douche 70 x 140 cm  
1 serviette 50 x 100 cm et 1 gant 16 x 22 cm

**T520** éponge coloris blanc

**T521** éponge coloris ardoise

**T522** éponge coloris kiwi

**T523** éponge coloris orange

**T524** éponge coloris taupe

**T525** éponge coloris rose-blossom

**T526** éponge coloris oxyde

**T527** éponge coloris bleu indigo



Photographies non contractuelles  
Reproduction interdite. © APEI 2024

# GAMME TEXTILE



**BLANCHE**

Éponge pur coton peigné 600 g/m<sup>2</sup>  
**SERVIETTE** 50 x 100 cm **T400**  
**DRAP DE DOUCHE** 70 x 140 cm **T430**  
**DRAP DE BAIN** 100 x 150 cm **T460**  
**GANT DE TOILETTE** 16 x 22 cm **T490**



**ARDOISE**

Éponge pur coton peigné 600 g/m<sup>2</sup>  
**T406**  
**T436**  
**T466**  
**T496**

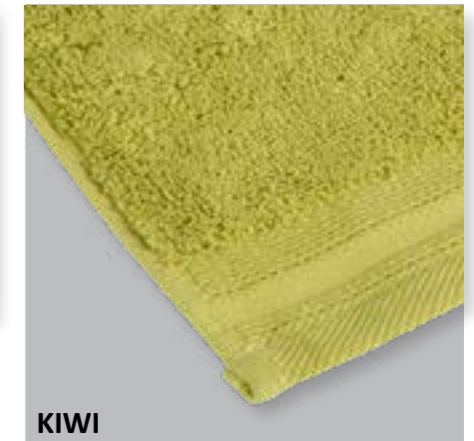

**KIWI**

Éponge pur coton peigné 600 g/m<sup>2</sup>  
**T421**  
**T451**  
**T481**  
**T511**



**ORANGE**

Éponge pur coton peigné 600 g/m<sup>2</sup>  
**T422**  
**T452**  
**T482**  
**T512**



**TAUPE**

Éponge pur coton peigné 600 g/m<sup>2</sup>  
**T423**  
**T453**  
**T483**  
**T513**



**ROSE-BLOSSOM**

Éponge pur coton peigné 600 g/m<sup>2</sup>  
**T424**  
**T454**  
**T484**  
**T514**



**OXYDE**

Éponge pur coton peigné 600 g/m<sup>2</sup>  
**T425**  
**T455**  
**T485**  
**T515**



**BLEU INDIGO**

Éponge pur coton peigné 600 g/m<sup>2</sup>  
**T426**  
**T456**  
**T486**  
**T516**



Photographies non contractuelles  
Reproduction interdite. © APEI 2024

# GAMME EPI



L'Artisanerie



L'Artisanerie

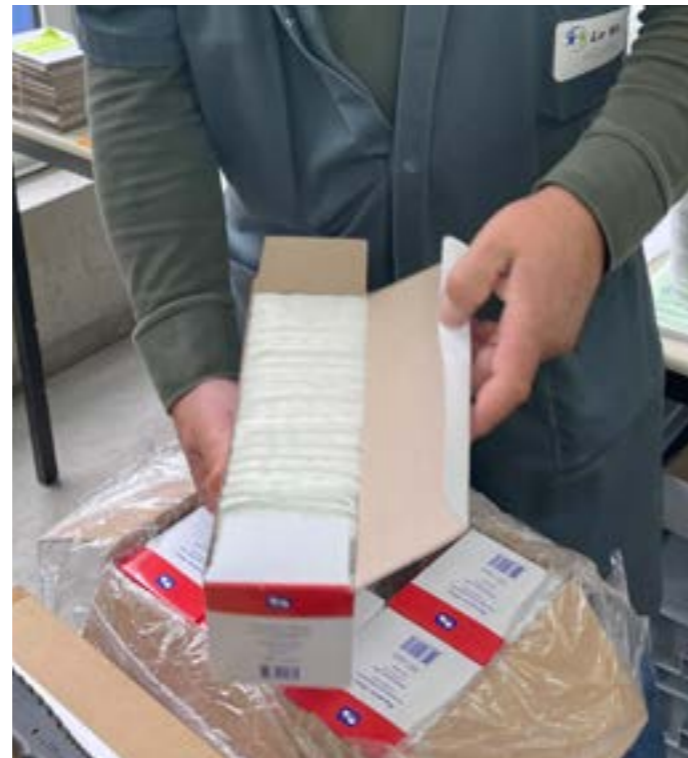

# GAMME EPI



**V805**  
TROUSSE DE SÉCURITÉ ROUTIÈRE  
Dimensions : 45 x 15 x 8 cm



**V806**  
ÉTUI DE SÉCURITÉ VÉHICULE



**V880**  
GILET DE SÉCURITÉ ORANGE FLUO  
Velcro réglable de la taille 100 à la taille 128. Avec bande réfléchissante  
Qualité polyester



**V881**  
GILET DE SÉCURITÉ JAUNE FLUO  
Velcro réglable de la taille 100 à la taille 128. Avec bande réfléchissante  
Qualité polyester



**V882**  
GILET DE SÉCURITÉ JAUNE FLUO  
Velcro non réglable. Avec bande réfléchissante. Qualité polyester



**V885**  
TRIANGLE DE SÉCURITÉ  
Lesté pour prise au vent



**G670**  
RUBAN DE SIGNALISATION EXTRA  
Rouleau de 100 m x 50 mm



**G675**  
RUBAN DE SIGNALISATION EXTRA  
Rouleau de 300 m x 70 mm

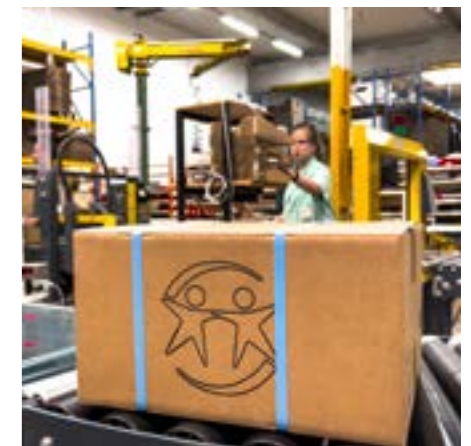

Photographies non contractuelles  
Reproduction interdite. © APEI 2024



# GAMME EPI



**E045**  
**TABLIER CONFORT PE EXTRA**  
**BLANC GAUFRÉ** Taille unique  
 100% polyéthylène - 40 µm



**E060**  
**COMBINAISON D'HYGIÈNE À**  
**CAPUCHE PP** Polypropylène 40 g/m<sup>2</sup>  
 Élastiques : capuche, poignets,  
 chevilles fermeture à glissière  
 E060 4 (taille 4) - E060 5 (taille 5)



**E070** CE  
**COMBINAISON HAUTE PROTECTION**  
**À CAPUCHE PP EXTRA BLANCHE**  
 Polypropylène SMS 65 g/m<sup>2</sup>  
 + membrane PE inter-respirante  
 Tailles : L (3) - XL (4) - XXL (5)



**E115**  
**KIT VISITEUR**  
 1 blouse en PE transparent  
 1 charlotte ronde blanche Ø 48 cm  
 1 masque papier 1 pli  
 1 paire de sur-chaussures CPE bleu



Photographies non contractuelles  
 Reproduction interdite. © APEI 2024

# GAMME EPI



**E001**  
**CHARLOTTE CLIP PP CONFORT**  
**BLANCHE**  
 Taille unique - 48 cm  
 100% polypropylène non tissé



**E020**  
**CALOT PAPIER RÉGLABLE**  
**EXTRA BLANC**  
 Avec liseré bleu, dessus perforé

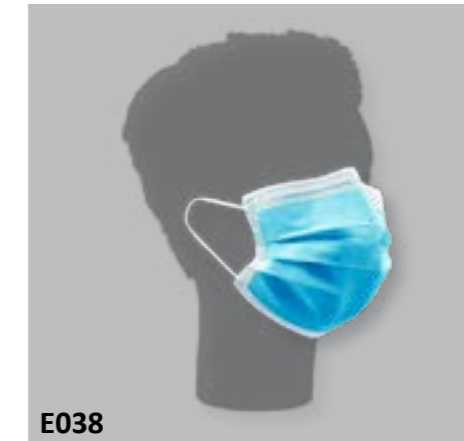

**E038**  
**MASQUE CHIRURGICAL TYPE II**  
**À ÉLASTIQUES**  
 Bleu. Masque 3 plis à usage unique



**E040** CE  
**MASQUE DE PROTECTION**  
**RESPIRATOIRE HAUTE**  
**FILTRATION BLANC**



**E042**  
**MASQUE BARRIÈRE**  
 Noir - 2 élastiques de maintien



**E075**  
**SURCHAUSSURES PE BLEUES**  
 Taille unique. 38 g/m<sup>2</sup>  
 Élastique de serrage à la cheville  
 Imperméable



**E090**  
**MANCHETTE ÉLASTIQUÉE BLEUE**  
 Polyéthylène 20 µm



Photographies non contractuelles  
 Reproduction interdite. © APEI 2024

# GAMME EPI



CE  
P136

**GANTS LATEX NATUREL ENDUIT ADHÉRISÉ**  
Dos aéré, poignée tricot  
Tailles : 7-8-9



CE  
P147

**GANTS ENDUIT NITRILE**  
Dos aéré, poignée tricot  
Tailles : 7-8-9



CE  
P150

**GANTS SANS COUTURE FIBRE POLYÉTHYLÈNE**  
Dos aéré, poignée tricot élastique  
Tailles : 8-9-10



CE  
P154

**GANTS SANS COUTURE ENDUIT POLYURÉTHANE**  
Dos aéré, poignée tricot  
Tailles : 8-9-10



CE  
P156

**GANTS SANS COUTURE ENDUIT NITRILE**  
Dos aéré, poignée tricot  
Tailles : 8-9-10



CE  
P162

**GANTS DOCKERS SUPER CROÛTE CUIR DE BOVIN ET TOILE**  
Taille unique



CE  
P168

**GANTS CUIR PLEINE FLEUR DE BOVIN**  
Hydrofuge avec protège artère  
Tailles : 8-9-10-11



CE  
P173

**GANTS CUIR PLEINE FLEUR DE BOVIN HYDROFUGE**  
Dextérité, confort, souplesse, résistance  
Tailles : 8-9-10



Photographies non contractuelles  
Reproduction interdite. © APEI 2024

# GAMME EPI



CE  
P118

**GANTS LATEX NATUREL CONFORT JAUNE.** Intérieur flocage coton  
Relief antidérapant paume et doigts  
Tailles : 6-7-8-9



CE  
P125

**GANTS LATEX NATUREL ÉPAIS LISSE BLEU** Intérieur support textile  
Bonne isolation au chaud. Manipulation de produits congelés - Tailles : 7-8-9



CE  
P144

**GANTS NITRILE FLOQUÉ VERT**  
Paume et doigts adhésifs. Haute résistance mécanique et chimique  
Tailles : 8-9-10



4 tailles panachées  
P101

**GANTS D'EXAMEN PVC VINYLE SOFT** sans poudre, ambidextres, non stériles, haute qualité, excellent confort tactile



4 tailles panachées  
P102

**GANTS D'EXAMEN PVC VINYLE SOFT** sans poudre, ambidextres, non stériles, haute qualité, excellent confort tactile



4 tailles panachées  
P104

**GANTS D'EXAMEN LATEX NATUREL** sans poudre, ambidextres, non stériles  
Surface extérieure texturée

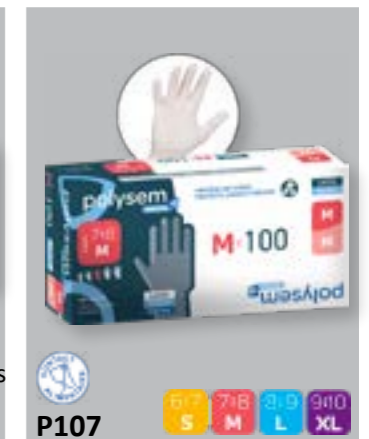

4 tailles panachées  
P107

**GANTS D'EXAMEN LATEX NATUREL** sans poudre, ambidextres, non stériles  
Surface extérieure texturée



4 tailles panachées  
P108

**GANTS D'EXAMEN NITRILE BLEU** sans poudre, ambidextres, non stériles  
Surface extérieure texturée



4 tailles panachées  
P110

**GANTS D'EXAMEN NITRILE BLEU** sans poudre, ambidextres, non stériles  
Surface extérieure texturée



4 tailles panachées  
w

**GANTS NITRILE NOIR**  
Sans poudre, ambidextres, non stériles  
Doigts texturés



4 tailles panachées  
P112

**GANTS NITRILE NOIR**  
Sans poudre, ambidextres, non stériles  
Doigts texturés



Photographies non contractuelles  
Reproduction interdite. © APEI 2024

# GAMME EPI



**V796**  
**TROUSSE DE SECOURS INDIVIDUELLE**  
 Dimensions : 160 x 120 x 50 mm



**V797**  
**TROUSSE DE SECOURS INDIVIDUELLE P.M.**  
 Dimensions : 215 x 135 x 60 mm



**V799**  
**TROUSSE DE SECOURS POUR VÉHICULES**  
 Dimensions : 220 x 180 x 70 mm



**V800**  
**COFFRET DE SECOURS POUR VÉHICULES**  
 Fourni avec support de fixation pour parois de coffre, surfaces planes, ...



**V800 9**  
**COFFRET DE SECOURS POUR VÉHICULES**  
 avec bandes velcro pour fixation sans trou



**V801**  
**COFFRET DE SECOURS POUR COLLECTIVITÉS**  
 Fourni avec support de fixation pour murs, surfaces planes, ...



**V802**  
**COFFRET DE SECOURS POUR ENTREPRISES**  
 Fourni avec support de fixation pour murs, surfaces planes, ...



**V807**  
**RECHARGE** pour coffret de secours **ENTREPRISES**



**V808**  
**RECHARGE** pour coffret de secours **VÉHICULES**



**V809**  
**RECHARGE** pour coffret de secours **COLLECTIVITÉS**



Photographies non contractuelles  
 Reproduction interdite. © APEI 2024

# GAMME EPI



**V827**  
**SERVIETTE ASSÉCHANTE CUTANÉE**

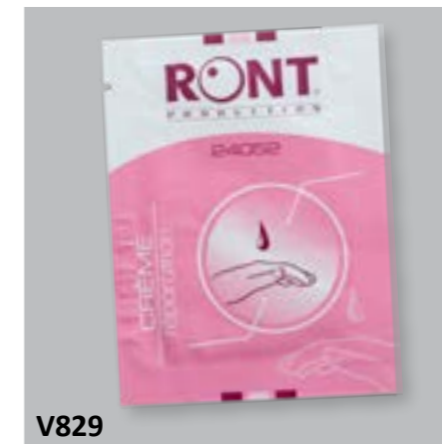

**V829**  
**CRÈME RÉPARATRICE**



**V830**  
**TAMPON ALCOOLISÉ À 70°**



**V831**  
**SERVIETTE NETTOYANTE ET DÉSINFECTANTE**



**V832**  
**SERVIETTE APAISANTE**



**V835**  
**PULVÉRISATEUR D'ALCOOL PUR ISOPROPYLIQUE À 70°**



**V836**  
**PULVÉRISATEUR DE CHLORHÉXIDINE**  
 Nettoyante de désinfectante



**V837**  
**PULVÉRISATEUR DE CALENDULA**  
 Soulage les coups



**V837 3**  
**PULVÉRISATEURS PANACHÉS**



Photographies non contractuelles  
 Reproduction interdite. © APEI 2024

# GAMME EPI



**V840**  
ÉCHARPE TRIANGULAIRE



**V844**  
COUVERTURE DE SURVIE  
Dimensions : 220 x 140 cm



**V845**  
EMBOUT POUR BOUCHE À BOUCHE



**V870**  
DISTRIBUTEUR DE  
PREMIERS SOINS  
50 serviettes nettoyantes  
100 pansements adhésifs



**V825**  
COUSSIN HÉMOSTATIQUE



**V841**  
LOT DE 12 ÉPINGLES DE  
SURETÉ

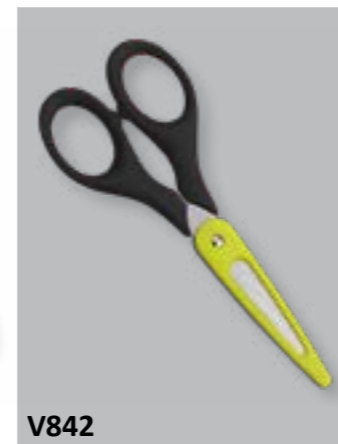

**V842**  
CISEAUX POUR  
COMPRESSES



**V843**  
PINCE À ÉCHARDE



**V849**  
ETHYLOTTEST  
À usage unique



**V838**  
PULVÉRISATEUR EAU STÉRILE  
NETTOYANTE



Photographies non contractuelles  
Reproduction interdite. © APEI 2024

# GAMME EPI



**V810**  
BANDE EXTENSIBLE  
3 m x 5 cm



**V811**  
BANDE EXTENSIBLE  
3 m x 10 cm



**V819**  
BANDE DE CRÊPE  
4 m x 10 cm



**V812**  
PANSEMENT COMPRESSIF STÉRILE  
4 m x 8 cm



**V813**  
COMPRESSE STÉRILE  
20 x 20 cm



**V822**  
SACHET DE 4 TAMPONS NON TISSÉS  
STÉRILES  
Ø 3 cm



**V823**  
COMPRESSE STÉRILE  
40 x 60 cm



**V824**  
COMPRESSE STÉRILE  
60 x 80 cm



**V821**  
PANSEMENT AUTO-ADHÉSIF  
Chair. 4,5 m x 6 cm



Photographies non contractuelles  
Reproduction interdite. © APEI 2024

# GAMME EPI



**V814**  
**ROULEAU DE SPARADRAP**  
5 m x 2 cm



**V815**  
**PANSEMENT ADHÉSIF**  
40 x 20 mm



**V816**  
**PANSEMENT ADHÉSIF**  
72 x 20 mm



**V817**  
**PANSEMENT ADHÉSIF**  
53 x 70 mm



**V846**  
**PANSEMENTS ADHÉSIFS PANACHÉS**  
12 pansements adhésifs 40 x 20 mm  
12 pansements adhésifs 72 x 20 mm  
6 pansements adhésifs 53 x 70 mm



**V826**  
**SACHET DE 5 SUTURES ADHÉSIVES STÉRILES**  
75 x 3 mm



**V818**  
**BANDE DE PANSEMENT ADHÉSIF**  
À découper  
1m x 6 cm



**V861**  
**GARROT TOURNIQUET**



# GAMME EPI



**V851**  
**PANSEMENT BLEU DÉTECTABLE**  
Pour milieu alimentaire  
72 x 19 mm



**V852**  
**PANSEMENT BLEU DÉTECTABLE**  
Pour milieu alimentaire  
180 x 20 mm



**V853**  
**PANSEMENT BLEU DÉTECTABLE**  
Pour milieu alimentaire, spécial jointure  
70 x 38 mm



**V854**  
**PANSEMENT BLEU DÉTECTABLE**  
Pour milieu alimentaire, spécial  
bout de doigt. 63 x 45 mm



**V855**  
**PANSEMENT BLEU DÉTECTABLE**  
Pour milieu alimentaire, spécial  
articulation. 105 x 105 mm



**V856**  
**ROULEAU DE SPARADRAP BLEU**  
Pour milieu alimentaire  
Non détectable. 5 m x 2,5 cm



**V857**  
**PANSEMENT AUTO-ADHÉSIF BLEU**  
4,5 m x 6 cm



**V859**  
**PANACHÉS DE PANSEMENTS BLEUS**



# GAMME EPI



**V803**  
COFFRET LAVE-CŒIL



**V833**  
DOSETTE DE SÉRUM  
PHYSIOLOGIQUE STÉRILE  
5 ml



**V834**  
COMPRESSE OCULAIRE STÉRILE  
Ø 6 cm



**V839**  
RECHARGE COFFRET LAVE-CŒIL



**V820**  
PAQUET DE COTON HYDROPHILE  
50 g



**V862**  
PACK DE FROID INSTANTANÉ



Remise diplôme de la **Reconnaissance Des Savoir-Faire Professionnels**



Photographies non contractuelles  
Reproduction interdite. © APEI 2024

# EPI Services



## MADE BY HANDICAPPED

La création d'un atelier d'entretien et de réparation de vêtement technique de catégorie 3 c'est « l'excellence » produite au sein de notre entreprise adaptée L'Artisanerie. Elle positionne le « Made By handicapped » au sommet de la chaîne qualitative mettant en lumière l'acquisition d'une technicité parfaite



répondant aux exigences techniques les plus poussées, protégeant ainsi la santé et assurant la sécurité des sapeurs-pompiers lors de leurs interventions. C'est la reconnaissance de savoir-faire professionnels acquis au sein de notre structure et transférable vers le milieu ordinaire.

Le handicap n'a pas besoin qu'on lui donne sa place, il la prend seul et la choisit !



# GAMME SERVICES GÉNÉRAUX



 Le Verdier

 Le Verdier



 L'Artisanerie

 Apei  
F. ARMANI  
MUNDOCHI

# GAMME SERVICES GÉNÉRAUX



**V950**  
**CAISSE D'EXPÉDITION**  
26 x 20 x 15 cm. Qualité C30



**V951**  
**CAISSE D'EXPÉDITION**  
33 x 30 x 15 cm. Qualité B20



**V952**  
**CAISSE D'EXPÉDITION**  
38 x 33 x 20 cm. Qualité C30



**V953**  
**CAISSE D'EXPÉDITION**  
38 x 33 x 33 cm. Qualité C30



**V954**  
**CAISSE D'EXPÉDITION**  
48 x 34 x 28 cm. Qualité C30



**V955**  
**CAISSE D'EXPÉDITION**  
67 x 33 x 22 cm. Qualité C30



**V956**  
**CAISSE D'EXPÉDITION**  
67 x 51 x 20 cm. Qualité C30



**V957**  
**CAISSE D'EXPÉDITION**  
67 x 51 x 33 cm. Qualité C30

## EMPLACEMENT POUR :

- Documents ci-inclus
- Adresse du destinataire
- Étiquette transporteur
- Mentions :  
Fragile  
Haut/Bas  
Vérifier votre livraison

**CARTON RECYCLÉ  
SIMPLE CANNELURE**

 Apei  
F. ARMANI  
MUNDOCHI

# GAMME SERVICES GÉNÉRAUX



**V555**  
**BOÎTE D'EXPÉDITION INVIOLENT A5**  
23,5 x 16 x 10 cm



**V556**  
**BOÎTE D'EXPÉDITION INVIOLENT A4**  
32,5 x 22 x 15 cm



**V944**  
**FILM ÉTIRABLE MANUEL RENFORCÉ** Transparent  
Laize 485 mm  
Longueur 300 m



**V946/V948**  
**FILM DE PROTECTION À BULLES** Recyclable  
V946 : 0,5 x 10 m  
V948 : 1 x 10 m



**V559**  
**POCHETTE D'EXPÉDITION PAPIER AUTO-ADHÉSIVE**  
120 x 162 mm (A4 plié en 4)  
"Documents ci-inclus"



**V557**  
**POCHETTE D'EXPÉDITION PAPIER AUTO-ADHÉSIVE**  
165 x 228 mm (A4 plié en 2)  
"Documents ci-inclus"



**V558**  
**POCHETTE D'EXPÉDITION PAPIER AUTO-ADHÉSIVE**  
120 x 228 mm (A4 plié en 3)  
"Documents ci-inclus"



**F242**  
**POCHETTE ZIPPÉE EN PVC RENFORCÉ**  
13 x 17 cm



**F244**  
**POCHETTE ZIPPÉE EN PVC RENFORCÉ**  
19 x 25 cm



**F246**  
**POCHETTE ZIPPÉE EN PVC RENFORCÉ**  
26 x 34,5 cm



Photographies non contractuelles  
Reproduction interdite. © APEI 2024

# GAMME SERVICES GÉNÉRAUX



**V602**  
**RUBAN ADHÉSIF**  
Polypropylène - Transparent  
Armé - 50 mm x 50 m



**V603 2**  
**RUBAN ADHÉSIF DE MASQUAGE**  
Papier crêpe - 19 mm x 50 m



**V604**  
**RUBAN ADHÉSIF DE MASQUAGE**  
Papier crêpé - 50 mm x 50 m

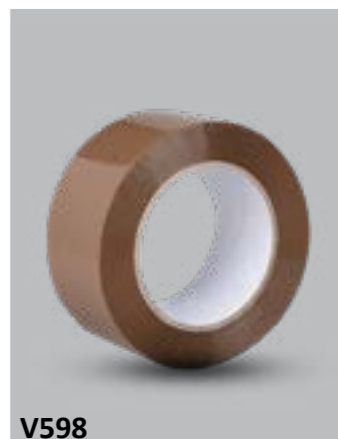

**V598**  
**RUBAN ADHÉSIF**  
Polypropylène  
Havane - 50 mm x 100 m



**V600**  
**RUBAN ADHÉSIF**  
Papier semi-crêpé imprégné  
Havane - 50 mm x 50 m



**V601**  
**RUBAN ADHÉSIF**  
Polypropylène - Transparent  
50 mm x 100 m



**V599**  
**DÉVIDOIR PISTOLET MANUEL**  
Frein de réglage pour adhésif



**V596**  
**RUBAN ADHÉSIF INVISIBLE**  
19 mm x 66 m



**V597**  
**DÉVIDOIR LOURD**  
Pour ruban adhésif 66 m  
Jusqu'à 25 mm de large  
Livré avec un rouleau adhésif



**V595**  
**DÉVIDOIR LOURD**  
Pour ruban adhésif 33 ou 66 m



**V593**  
**RUBAN ADHÉSIF INVISIBLE**  
19 mm x 33 m



Photographies non contractuelles  
Reproduction interdite. © APEI 2024



# GAMME SERVICES GÉNÉRAUX



**V962**  
**CORBEILLE DE TRI SÉLECTIF**  
Carton kraft brun  
Couvercle couleurs au choix :  
bleu, rouge, vert ou jaune



**V963**  
**CORBEILLE DE TRI SÉLECTIF**  
Carton kraft brun - 60 L  
Couleurs panachées



**V970**  
**COLLECTEUR DE PAPIER**  
Avec couvercle. 3 poignées. Témoin  
de remplissage. Intérieur et  
extérieur en carton kraft brun



**F290**  
**CORBEILLE À PAPIER**  
Carton kraft brun



**F300**  
**PRÉSENTOIR MURAL**  
Carton kraft brun



**F292**  
**POT À CRAYONS**  
4 compartiments  
Carton kraft brun



**F294**  
**CORBEILLE À COURRIER  
SUPERPOSABLE**  
Pour format A4  
Carton kraft brun



**F296**  
**BOÎTE DE CLASSEMENT À PAN  
COUPÉ**  
Carton kraft brun



Photographies non contractuelles  
Reproduction interdite. © APEI 2024

# GAMME SERVICES GÉNÉRAUX



**V738**  
**DISTRIBUTEUR DE TROMBONES**  
Aimanté. Plastique brillant rigide noir



**V739**  
**POT À CRAYONS**  
4 compartiments  
Plastique brillant rigide noir



**V741**  
**CORBEILLE À COURRIER**  
Supersposable pour format A4  
Plastique brillant rigide noir



**V742**  
**BOÎTE DE CLASSEMENT**  
À pan coupé. Plastique brillant  
rigide noir



**V743**  
**POUBELLE DE BUREAU**  
Plastique brillant rigide noir. 18 L



**F367**  
**REPOSE PIEDS ERGONOMIQUE**  
Surface bosselée  
Inclinaison réglable



**V744**  
**PARURE DE BUREAU**  
- Dévidoir lourd pour ruban adhésif  
- Stylo bille sur socle lesté  
- Distributeur de trombones aimanté  
- Pot à crayons 4 compartiments  
- Corbeille à courrier superposable  
- Boîte de classement à pan coupé  
- Poubelle de bureau



**V746**  
**MODULE DE CLASSEMENT**  
Plastique noir et multicolore  
5 tiroirs - 347 x 278 x 271 mm



Photographies non contractuelles  
Reproduction interdite. © APEI 2024

# GAMME SERVICES GÉNÉRAUX



**V733**  
**ARMOIRE À CLÉS**  
20 crochets - Métal gris  
Serrure de sécurité



**V734**  
**ARMOIRE À CLÉS**  
48 crochets - Métal gris  
Serrure de sécurité



**V732**  
**COFFRET CAISSE "EURO"**  
2 poignées - Métal gris clair  
Serrure de sécurité



**V389**  
**SUPPORT À PINCE PVC**  
Pince métal avec plastique aux angles.  
Cillet de suspension. Porte stylo



**V354**  
**PORTE CARTES DE VISITE**  
120 cartes  
Intercalaires alphabétiques



**V735**  
**PORTE-CLÉS "ÉTIQUETTES"**  
Plastique. Couleurs panachées :  
5 bleu, 5 rouge, 5 vert, 5 jaune et 5 noir



**V340**  
**CARNET AUTOCOPIANT QUADRILLÉ**  
5x5  
50 feuillets - 2 plis numérotés



**V341**  
**CARNET AUTOCOPIANT FACTURES**  
50 feuillets  
2 plis numérotés



**V348**  
**BOBINE PAPIER THERMIQUE**  
Pour terminal de carte bancaire  
Sans biphénol A

# GAMME SERVICES GÉNÉRAUX



**V695**  
**CALCULETTE DE POCHE**  
**RABBATABLE**  
Écran LCD 10 chiffres



**V696**  
**CALCULETTE DE POCHE**  
Conversion de devises  
Mémoire



**V697**  
**CALCULETTE DE BUREAU**  
Écran à inclinaison réglable  
Écran LCD à 10 chiffres

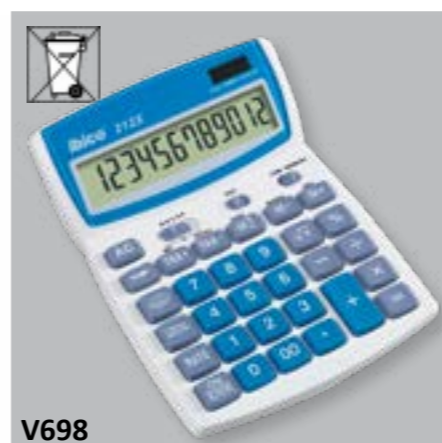

**V698**  
**CALCULETTE DE BUREAU**  
Écran inclinable à 12 chiffres  
Fonction TAX +/-  
Fonction arrondi



**V701**  
**CLÉ USB 8GO**



**V702**  
**CLÉ USB 16GO**



**V703**  
**CLÉ USB 32GO**



**V780**  
**DESTRUCTEUR DE DOCUMENTS**  
Pour format A4. Max 12 feuilles de 80g  
Coupe en bandes 3,9 mm  
Corbeille 20 L



**V781**  
**DESTRUCTEUR DE DOCUMENTS**  
Pour format A4. Max 13 feuilles de 80g  
CD/DVD  
Coupe en particules 4 x 37 mm  
Corbeille 23 L

# GAMME SERVICES GÉNÉRAUX



CADRE MAGNÉTIQUE DURABLE



A4

V276/V276 0

**POCHETTE ADHÉSIVE REPOSITIONNABLE**  
Format A4

CADRE MAGNÉTIQUE DURABLE



A5

V276 5

**POCHETTE ADHÉSIVE REPOSITIONNABLE**  
Format A5

CADRE MAGNÉTIQUE DURABLE



A3

V276 3

**POCHETTE ADHÉSIVE REPOSITIONNABLE**  
Format A3

# GAMME SERVICES GÉNÉRAUX



V726

**TABLEAU BIVALENT**  
Laqué blanc magnétique et liège aggloméré. 60 x 90 cm



V727

**TABLEAU D'AFFICHAGE**  
Fond liège aggloméré. 45 x 60 cm



V728

**TABLEAU**  
Tableau d'écriture ou d'affichage magnétique. Fond laqué blanc. 45 x 60 cm



A3

A4

A5

V277

**POCHETTE ADHÉSIVE REPOSITIONNABLE**  
Panaché : 1 format A3 + 2 formats A4 + 2 formats A5



A4

V282

**POCHETTE ADHÉSIVE REPOSITIONNABLE**  
Format A4



V275

**POCHETTE ADHÉSIVE TRANSPARENTE POUR AFFICHAGE MURAL**  
Pour documents A4. Ouverture côté droit pour présentation verticale



V729

**TABLEAU**  
Tableau d'écriture ou d'affichage magnétique. Fond laqué blanc. 60 x 90 cm



V231

**PARAPHEUR NOIR**  
12 compartiments - Pochette de maintien signature. Couverture plastifiée

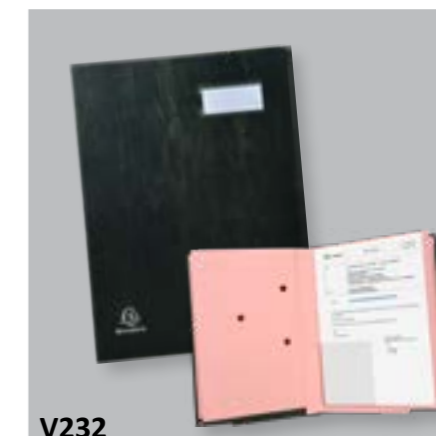

V232

**PARAPHEUR NOIR**  
24 compartiments - Pochette de maintien signature. Couverture plastifiée



A4

V280

**POCHETTE VITRO STATIQUE REPOSITIONNABLE**  
Cadre magnétique "DURABLE" Format A4



A3

V280 3

**POCHETTE VITRO STATIQUE REPOSITIONNABLE**  
Cadre magnétique "DURABLE" Format A3

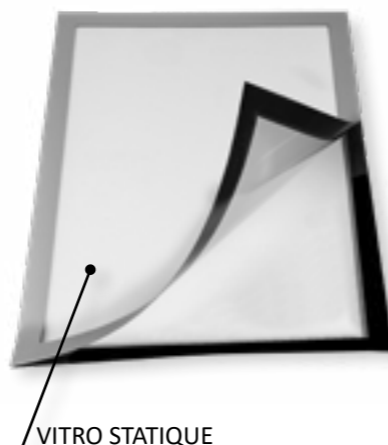

VITRO STATIQUE



F380

**TAPIS DE SOL DE VOITURE EN PAPIER**  
50 feuilles détachables 33 x 48,7 cm



Photographies non contractuelles  
Reproduction interdite. © APEI 2024



Photographies non contractuelles  
Reproduction interdite. © APEI 2024

# GAMME SERVICES GÉNÉRAUX



**F366**  
**MARCHE-PIEDS PLIANT ALUMINIUM**  
Double pieds 1 marche  
Hauteur : 40 cm



**F360**  
**TABOURET ROULANT MÉTAL**  
150 kg  
Marche-pieds 2 marches



**F365**  
**ESCABEAU ACIER LAQUÉ**  
150 kg  
2 marches



**F364**  
**ESCABEAU 3 MARCHES**  
Garde corps  
Acier epoxy blanc  
150 kg



**F370/F371**  
**DIABLE PLIANT ALUMINIUM**  
F370 L= 38 cm. Charge maxi 50 kg  
F371 L= 48 cm. Charge maxi 100 kg



**F374**  
**CHARIOT CARGO**  
Charge maxi 250 kg  
2 roues fixes et 2 roues pivotantes  
Lever rabattable au pied



**D145**  
**SUPPORT MOBILE À PÉDALE GRIS POUR SAC 110L**  
Coloris couvercle disponibles : gris, blanc, vert, jaune ou bleu



**A694**  
**DÉROULEUR SUR PIED MOBILE**  
Pour bobines industrielles avec support sac 110L. Acier poudré blanc  
Bobine jusqu'à Ø 36 cm, 37 cm de large

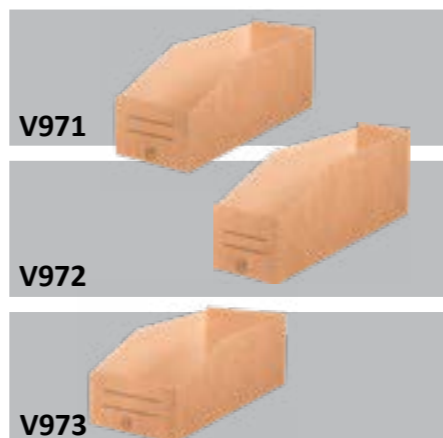

**V971**  
**V972**  
**V973**  
**BAC À BEC EN CARTON KRAFT**  
Carton kraft B20. Simple cannelure  
V971 capacité : 2,8 L  
V972 capacité : 1,3 L  
V973 capacité : 4,3 L



Photographies non contractuelles  
Reproduction interdite. © APEI 2024

# GAMME SERVICES GÉNÉRAUX



**V975**  
**GOBELET CARTON**  
Compatible distribution manuelle



**V976**  
**GOBELET CARTON**



**V977**  
**GOBELET CARTON**



**V978**  
**GOBELET CARTON**



**F343**  
**SAC KRAFT BRUN**  
35 x 34,5 x 14 cm. Poignées torsadées  
Papier kraft vergé



**F345**  
**SAC KRAFT BRUN**  
26 x 28 x 20 cm. Poignées plates



**F341**  
**SAC CABAS BOUTEILLE ROUGE**  
14 x 8 x 39 cm. Poignées torsadées  
Papier kraft vergé 110 g/m<sup>2</sup>



**F342**  
**SAC CABAS BOUTEILLE ÉCRU**  
14 x 8 x 39 cm. Poignées torsadées  
Papier kraft vergé 110 g/m<sup>2</sup>



Photographies non contractuelles  
Reproduction interdite. © APEI 2024

# GAMME SERVICES GÉNÉRAUX



W750 2    W750 3    W750 4    W750 5    W750 6    W750 7

**AGENDA PLANNING HEBDOMADAIRE 2025**  
Couverture liseuse avec piqûre - 9 x 16,5 cm



W748 2    W748 3    W748 4    W748 5    W748 6    W748 7

**AGENDA PLANNING HEBDOMADAIRE 2025**  
Couverture liseuse avec piqûre - 27 x 21 cm



V750 5  
**AGENDA HEBDOMADAIRE DE POCHE 2025** 9 x 16,5 cm  
Couverture liseuse noire avec piqûre



V748 5  
**AGENDA PLANNING HEBDOMADAIRE 2025** 27 x 21 cm  
Couverture liseuse noire avec piqûre



V749 5  
**AGENDA PLANNING JOURNALIER 2025** 14 x 21 cm  
Couverture cartonnée noire



Photographies non contractuelles  
Reproduction interdite. © APEI 2024

# GAMME SERVICES GÉNÉRAUX



V764 5  
**CALENDRIER PLAQUE ANNUEL 2025**  
Semaines numérotées, 14 mois sur 1 face. Jours croissants / décroissants



V752 5  
**CALENDRIER PLAQUE SEMESTRIEL 2025**  
Semaines numérotées, 7 mois par face

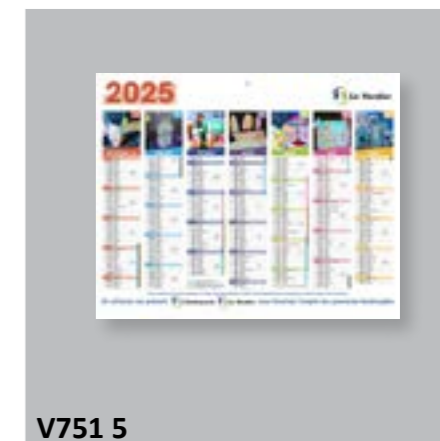

V751 5  
**CALENDRIER PLAQUE SEMESTRIEL 2025**  
Semaines numérotées, 7 mois par face



V753 5  
**CALENDRIER PLAQUE SEMESTRIEL 2025**  
Semaines numérotées, 7 mois par face



V765 5  
**CALENDRIER PLAQUE ANNUEL 2025**  
Formats panachés



V755 5  
**SOUS-MAINS IMPRIMÉ CALENDRIER ANNUEL 2025**  
24 feuilles détachables



V763 5  
**CHEVALET DE BUREAU**  
Calendrier mensuel 108 x 65 mm  
50 papillons adhésifs 100 x 75 mm  
125 index couleurs polyester 12 x 50 mm



V759 5



V757 5  
**BLOC ÉPHÉMÉRIDE 2025 SUPPORT BOIS**



V761 5



V758 5  
**RECHARGE BLOC ÉPHÉMÉRIDE 2025**



Photographies non contractuelles  
Reproduction interdite. © APEI 2024

# GAMME SERVICES GÉNÉRAUX



**PERSONNALISEZ VOS BLOCS**  
Réalisation sur demande



**PERSONNALISEZ VOS CHEVALETS**  
Réalisation sur demande



**PERSONNALISEZ VOS ENVELOPPES**  
Réalisation sur demande



**PERSONNALISEZ VOS CALENDRIERS**  
Réalisation sur demande



**PERSONNALISEZ VOS BLOCS-LIVRE**  
Réalisation sur demande



# GAMME SERVICES GÉNÉRAUX



**V760**  
**CARTES DE CORRESPONDANCE DOUBLE**  
12 modèles différents en couleur + 12 enveloppes  
Format 21 x 10,5 cm



**V762**  
**CARTES DE CORRESPONDANCE DOUBLE « NATURE »**  
12 modèles différents en couleur + 12 enveloppes  
Format 21 x 10,5 cm



Œuvres réalisées par les adultes handicapés de l'atelier d'expressions plastiques de l'APEI de Saint-Amand-Montrond, accompagnés par Ludivine Barbault, artiste intervenante.

# GAMME PAPETERIE



 Le Verdier



 Le Verdier



 Le Verdier



 Le Verdier

 Apei  
F. ARMANDI  
MONTICIONI

# GAMME PAPETERIE



**V068**  
**BLOC LIVRE 250 PAPILLONS**  
**ADHÉSIFS JAUNE**  
10 x 7,5 cm



**V069**  
**BLOC LIVRE 200 PAPILLONS**  
**ADHÉSIFS 4 COULEURS**  
7,5 x 7,5 cm



**V072**  
**BLOC LIVRE 200 PAPILLONS**  
**ADHÉSIFS 4 COULEURS**  
12,5 x 7,5 cm



**V075**  
**BLOC LIVRE 3 FONCTIONS FORMAT A6**  
80 papillons adhésifs jaune vif lignés  
1 bloc marque-pages  
100 feuilles blanches quadrillées



**V073**  
**BLOC LIVRE MESSAGE**  
1 bloc de 50 feuilles message  
téléphonique adhésif  
2 blocs de 50 papillons adhésifs



**V076**  
**LIVRE MARQUE-PAGES**  
160 index papier 20 x 50 mm  
125 index polyester 12 x 50 mm



**V077**  
**LIVRE MARQUE-PAGES**  
160 index papier 20 x 50 mm  
144 index polyester en "Z"  
12,5 x 43 mm



**V078**  
**LIVRE MARQUE-PAGES**  
300 index polyester en "Z"  
25 x 43 mm



**V079**  
**LIVRE MARQUE-PAGES**  
250 flèches PET  
(polyéthylène téréphtalate)  
25 x 45 mm

 Apei  
F. ARMANDI  
MONTICIONI

# GAMME PAPETERIE



**V059**  
DISTRIBUTEUR POUR  
PAPILLONS ADHÉSIFS EN "Z"  
Fourni avec une recharge  
V062

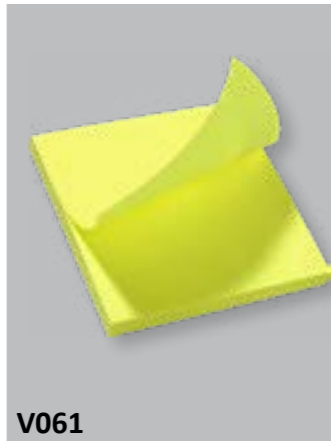

**V061**  
PAPILLONS ADHÉSIFS  
JAUNE VIF  
7,5 X 7,5 cm



**V062**  
PAPILLONS ADHÉSIFS  
EN "Z" 7,5 x 7,5 cm  
Au choix : vert, jaune ou  
rose-jaune



**V063**  
PAPILLONS ADHÉSIFS  
JAUNE VIF LIGNÉ  
10 x 10 cm



**V066**  
PAPILLONS ADHÉSIFS  
4 COULEURS  
5 x 4 cm



**V060**  
PAPILLONS ADHÉSIFS  
JAUNE  
7,5 X 7,5 cm



**V065**  
PAPILLONS ADHÉSIFS  
JAUNE  
5 X 4 cm



**V070**  
PAPILLONS ADHÉSIFS  
JAUNE  
12,5 X 7,5 cm



**V055**  
PAPILLONS ADHÉSIFS  
QUADRILLÉS 5x5 JAUNE  
10 x 15 cm



**V080**  
BLOC MESSAGE  
TÉLÉPHONIQUE ADHÉSIF  
1 bloc de 50 feuilles message  
10 x 14,8 cm

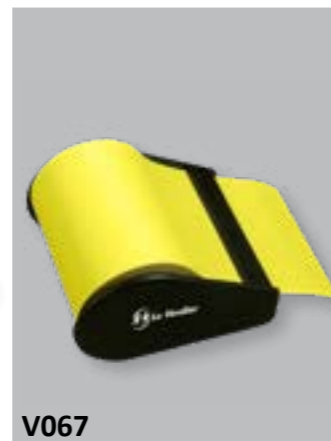

**V067**  
DÉVIDOIR DE PAPILLONS  
ADHÉSIFS  
REPOSITIONNABLES  
Jaune - 6 cm x 10 m

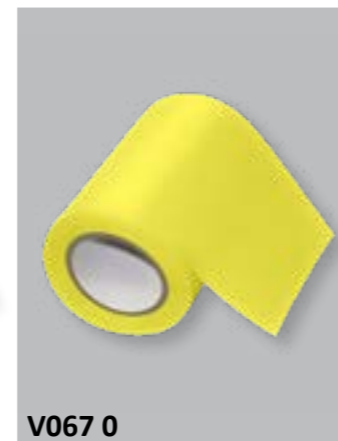

**V067 0**  
ROULEAU RECHARGE  
PAPILLONS ADHÉSIFS  
REPOSITIONNABLES  
Jaune - 6 cm x 10 m



Photographies non contractuelles  
Reproduction interdite. © APEI 2024

# GAMME PAPETERIE



**V050**  
BLOC CUBE DOS ENCOLLÉ  
900 feuilles - 9 x 9 x 9 cm  
Logo LE VERDIER



**V051**  
BOITIER BLOC CUBE + RECHARGE  
800 feuilles - 9 x 9 x 8 cm



**V052**  
RECHARGE BLOCS CUBE  
800 feuilles - 9 x 9 x 8 cm



**V053**  
BLOC CUBE DOS ENCOLLÉ  
800 feuilles - 10 x 10 x 10 cm  
Papillons adhésifs jaune vif ligné



**V054**  
BLOC CUBE DOS ENCOLLÉ  
900 feuilles - 9 x 9 x 9 cm



**V056**  
CUBE PAPILLONS ADHÉSIFS  
320 feuilles par bloc 7,5 x 7,5 cm  
4 couleurs vives



**V057**  
CUBE PAPILLONS ADHÉSIFS  
400 feuilles par bloc 7,5 x 7,5 cm  
4 couleurs pastels "ICELAND"



**V058**  
CUBE PAPILLONS ADHÉSIFS  
4 couleurs. Coloris nature  
Papier recyclé. 400 feuilles  
7,5 x 7,5 cm



**PERSONNALISEZ VOS BLOCS**  
Réalisation sur demande



Photographies non contractuelles  
Reproduction interdite. © APEI 2024



# GAMME PAPETERIE



**ENVELOPPE BLANCHE**  
114 x 162 mm  
Trapézoïdale - 90 g/m<sup>2</sup>



**ENVELOPPE BLANCHE**  
110 x 220 mm  
Trapézoïdale - 90 g/m<sup>2</sup>



**ENVELOPPE BLANCHE**  
110 x 220 mm  
Trapézoïdale - 90 g/m<sup>2</sup>



**ENVELOPPE BLANCHE À FENÊTRE**  
110 x 220 mm. Fenêtre 45 x 100 mm  
Trapézoïdale - 90 g/m<sup>2</sup>



**ENVELOPPE BLANCHE À FENÊTRE**  
110 x 220 mm. Fenêtre 45 x 100 mm  
Trapézoïdale - 80 g/m<sup>2</sup>



**ENVELOPPE BLANCHE À FENÊTRE**  
110 x 220 mm. Fenêtre 35 x 100 mm  
Trapézoïdale - 90 g/m<sup>2</sup>



**ENVELOPPE BLANCHE À FENÊTRE**  
110 x 220 mm. Fenêtre 35 x 100 mm  
Trapézoïdale - 80 g/m<sup>2</sup>



Photographies non contractuelles  
Reproduction interdite. © APEI 2024

# GAMME PAPETERIE



**ENVELOPPE BLANCHE À FENÊTRE VITREX.** 114 x 229 mm  
Fenêtre 35 x 100 mm - 80 g/m<sup>2</sup>



**ENVELOPPE BLANCHE À FENÊTRE VITREX.** 114 x 229 mm  
Fenêtre 45 x 100 mm - 80 g/m<sup>2</sup>



**ENVELOPPE BLANCHE**  
114 x 229 mm. 80 g/m<sup>2</sup>



**ENVELOPPE BLANCHE À FENÊTRE VITREX.** 115 x 225 mm  
Fenêtre 45 x 100 mm - 80 g/m<sup>2</sup>



**ENVELOPPE BLANCHE À FENÊTRE**  
162 x 229 mm. Fenêtre 45 x 100 mm  
Trapézoïdale - 90 g/m<sup>2</sup>



**POCHETTE BLANCHE**  
Format A5  
Velin blanc - 90 g/m<sup>2</sup>



**POCHETTE BLANCHE**  
229 x 324 mm  
Velin blanc - 90 g/m<sup>2</sup>



**POCHETTE BLANCHE À FENÊTRE**  
229 x 324 mm - Fenêtre 50 x 110 mm  
Velin blanc - 90 g/m<sup>2</sup>



Photographies non contractuelles  
Reproduction interdite. © APEI 2024

# GAMME PAPETERIE



**V514**  
**POCHETTE KRAFT À FENÊTRE**  
**229 x 324 mm**  
 Fenêtre 50 x 110 mm  
 Adour - 90 g/m<sup>2</sup>



**V529**  
**POCHETTE KRAFT À SOUFFLET**  
**ARMÉ 176 x 250 mm**  
 Soufflet 30 mm  
 130 g/m<sup>2</sup>



**V530**  
**POCHETTE KRAFT À SOUFFLET**  
**ARMÉ 229 x 324 mm**  
 Soufflet 30 mm  
 130 g/m<sup>2</sup>



**V531**  
**POCHETTE KRAFT À SOUFFLET**  
**ARMÉ 260 x 330 mm**  
 Soufflet 30 mm  
 130 g/m<sup>2</sup>



**V532**  
**POCHETTE KRAFT À SOUFFLET**  
**ARMÉ 275 x 365 mm**  
 Soufflet 30 mm  
 130 g/m<sup>2</sup>



**V520**  
**POCHETTE KRAFT À SOUFFLET**  
**229 x 324 mm**  
 Soufflet 30 mm  
 120 g/m<sup>2</sup>



**V521**  
**POCHETTE KRAFT À SOUFFLET**  
**260 x 330 mm**  
 Soufflet 30 mm  
 120 g/m<sup>2</sup>



**V522**  
**POCHETTE KRAFT À SOUFFLET**  
**275 x 365 mm**  
 Soufflet 30 mm  
 120 g/m<sup>2</sup>



Photographies non contractuelles  
 Reproduction interdite. © APEI 2024

# GAMME PAPETERIE



**V510/V510 1**  
**POCHETTE KRAFT**  
 162 x 229 mm. Demi A4  
 Vergé - 90 g/m<sup>2</sup>



**V511**  
**POCHETTE KRAFT**  
 176 x 250 mm  
 Vergé - 90 g/m<sup>2</sup>



**V512/V512 1**  
**POCHETTE KRAFT**  
 229 x 324 mm  
 Vergé - 90 g/m<sup>2</sup>



**V513**  
**POCHETTE KRAFT**  
 260 x 330 mm  
 Adour - 120 g/m<sup>2</sup>



**V545**  
**POCHETTE BULLE PAPIER**  
**KRAFT BRUN**  
 150 x 215 mm  
 90 g/m<sup>2</sup>



**V546**  
**POCHETTE BULLE PAPIER**  
**KRAFT BRUN**  
 220 x 265 mm  
 90 g/m<sup>2</sup>



**V547**  
**POCHETTE BULLE PAPIER**  
**KRAFT BRUN**  
 270 x 360 mm  
 90 g/m<sup>2</sup>



**V549**  
**POCHETTE KRAFT COURRIER**  
**INTERNE 260 x 330 mm**  
 Fermeture avec adhésif  
 repositionnable



Photographies non contractuelles  
 Reproduction interdite. © APEI 2024

# GAMME PAPETERIE

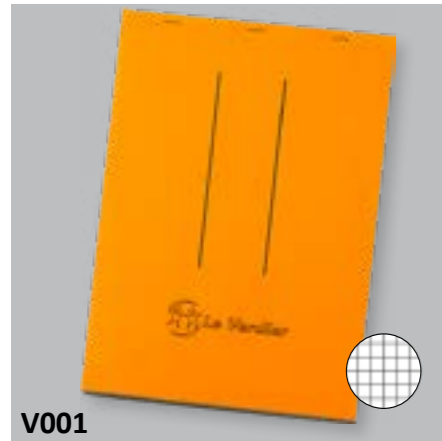

**V001**  
**BLOC DIRECTION FORMAT A4**  
 100 feuilles - 65 g/m<sup>2</sup>  
 Détaché - Quadrillage 5 x 5



**V002**  
**BLOC DIRECTION FORMAT A4**  
 100 feuilles perforées - 65 g/m<sup>2</sup>  
 Détaché - Quadrillage 5 x 5

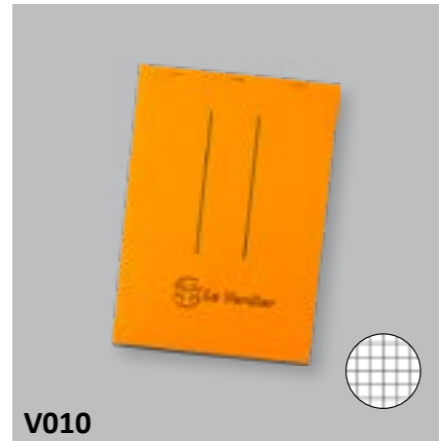

**V010**  
**BLOC DIRECTION FORMAT A5**  
 100 feuilles perforées - 65 g/m<sup>2</sup>  
 Détaché - Quadrillage 5 x 5



**V013**  
**BLOC NOTE FORMAT A6**  
 100 feuilles perforées - 65 g/m<sup>2</sup>  
 Détaché - Quadrillage 5 x 5

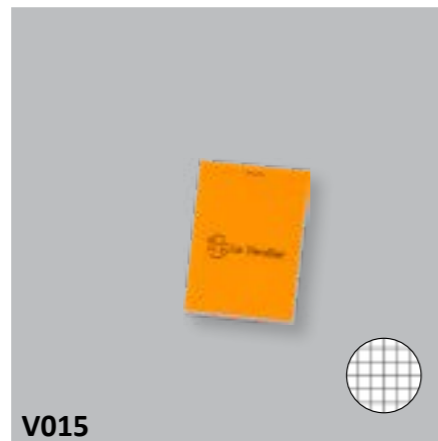

**V015**  
**BLOC NOTE FORMAT A7**  
 100 feuilles perforées - 65 g/m<sup>2</sup>  
 Détaché - Quadrillage 5 x 5



**V020**  
**BLOC DIRECTION FORMAT A4**  
 100 feuilles perforées - 65 g/m<sup>2</sup>  
 Détaché - Quadrillage 5 x 5



**V021**  
**BLOC DIRECTION A4**  
 100 feuilles perforées - 65 g  
 Détaché - Quadrillage 5 x 5



**V022**  
**BLOC DIRECTION A5**  
 100 feuilles - 65 g  
 Détaché - Quadrillage 5 x 5



**V023**  
**BLOC NOTE A6**  
 100 feuilles - 65 g  
 Détaché - Quadrillage 5 x 5



**V024**  
**BLOC NOTE A7**  
 100 feuilles - 65 g  
 Détaché - Quadrillage 5 x 5

# GAMME PAPETERIE



**V393**  
**CAHIER À SPIRALES QUADRILLÉ 5/5**  
 17 x 22 cm - 180 pages  
 Papier blanc 90g  
 Couverture carte pelliculée



**V394**  
**CAHIER À SPIRALES QUADRILLÉ 5/5**  
 A4 - 180 pages  
 Papier blanc 90g  
 Couverture carte pelliculée



**V396**  
**CAHIER ORGANISATEUR PERSONNEL À SPIRALES.** 160 pages A4 détachables.  
 Couverture rigide. 4 bandes de couleur  
 Perforation universelle



**V397**  
**CAHIER ORGANISATEUR PERSONNEL À SPIRALES.** 240 pages A4 détachables.  
 Couverture rigide. 4 bandes de couleur  
 Perforation universelle



**V398**  
**CAHIER ORGANISATEUR PERSONNEL À SPIRALES.** 160 pages A4 détachables.  
 Couverture souple. 4 bandes de couleur  
 Perforation universelle



**V399**  
**CAHIER ORGANISATEUR PERSONNEL À SPIRALES.** 240 pages A4 détachables.  
 Couverture souple. 4 bandes de couleur  
 Perforation universelle

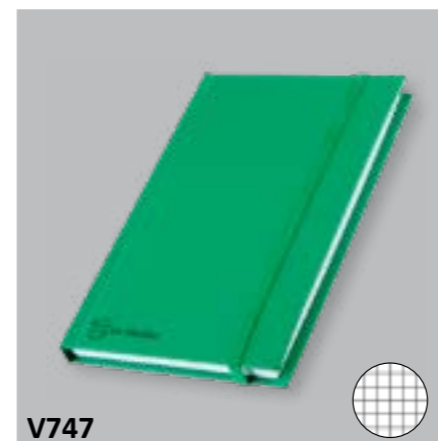

**V747**  
**CARNET DE POCHE**  
 100 pages - Quadrillé 5/5 avec élastique de fermeture

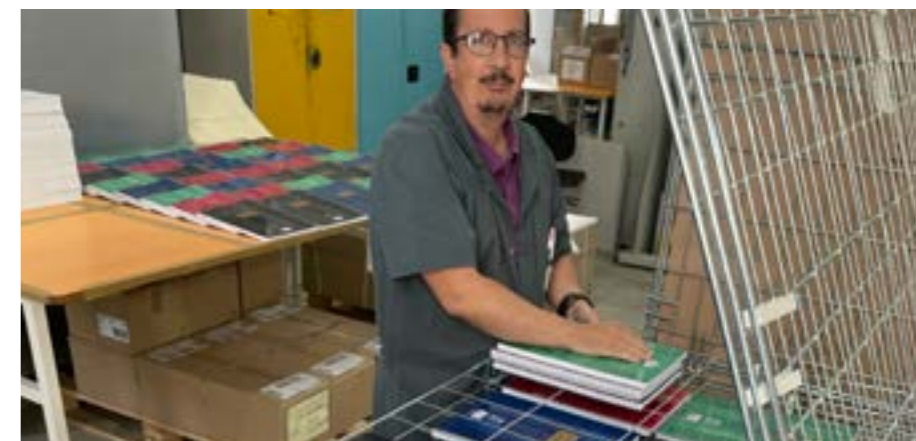

# GAMME PAPETERIE



**V287**  
**PROTÈGE DOCUMENT A4**  
Noir - 60 pochettes transparentes  
et interchangeables



**V288**  
**PROTÈGE DOCUMENT A4**  
Couleurs panachées - 30 pochettes  
transparentes et interchangeables



**V289**  
**PROTÈGE DOCUMENT A4**  
Bleu - 30 pochettes transparentes  
et interchangeables



**V290**  
**PROTÈGE DOCUMENT A4**  
Rouge - 30 pochettes transparentes  
et interchangeables



**V291**  
**PROTÈGE DOCUMENT A4**  
Noir - 30 pochettes transparentes  
et interchangeables



**V293**  
**RECHARGE DE POCHETTES  
TRANSPARENTES**  
Polypropylène



**V294**  
**RECHARGE DE POCHETTES  
TRANSPARENTES**  
Ouverture coin gauche  
Polypropylène



**V292**  
**INTERCALAIRES 12 TOUCHES**  
Couleurs panachées  
Polypropylène

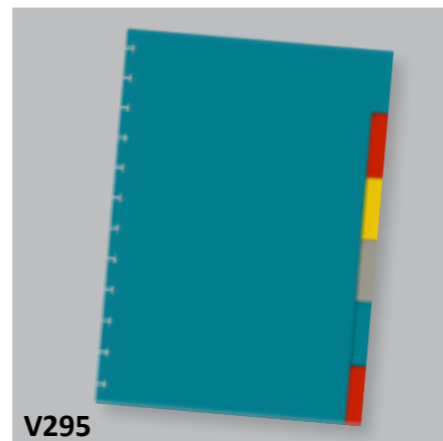

**V295**  
**INTERCALAIRES 6 TOUCHES**  
Couleurs panachées  
Polypropylène



Photographies non contractuelles  
Reproduction interdite. © APEI 2024

# GAMME PAPETERIE

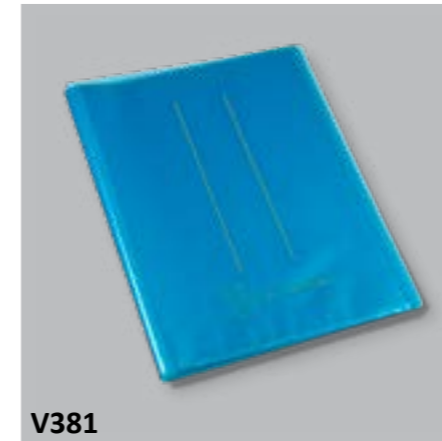

**V381**  
**PROTÈGE DOCUMENT SOUPLE**  
30 pochettes 60 vues A4  
Couleurs au choix :  
incolore, bleu, rouge ou vert



**V382**  
**PROTÈGE DOCUMENT SOUPLE**  
30 pochettes 60 vues A4  
Couleurs panachées :  
incolore, bleu, rouge et vert

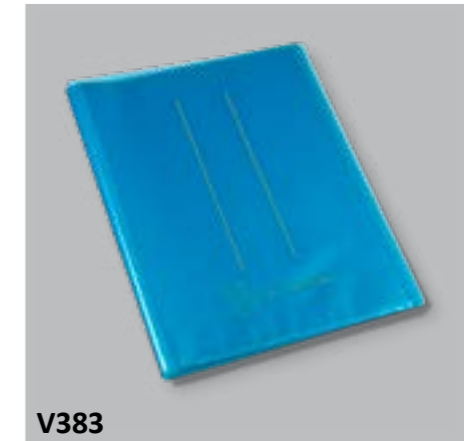

**V383**  
**PROTÈGE DOCUMENT SOUPLE**  
50 pochettes 100 vues A4  
Couleurs au choix :  
incolore, bleu, rouge ou vert

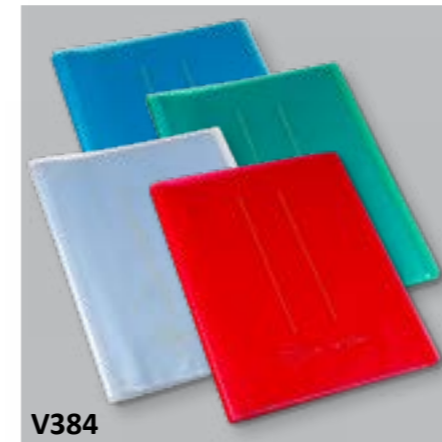

**V384**  
**PROTÈGE DOCUMENT SOUPLE**  
50 pochettes 100 vues A4  
Couleurs panachées :  
incolore, bleu, rouge et vert



**V385**  
**PERSONNALISABLE**  
**PROTÈGE DOCUMENT SOUPLE**  
20 pochettes 40 vues A4  
Couleurs au choix :  
incolore, bleu, rouge ou vert



**V386**  
**PERSONNALISABLE**  
**PROTÈGE DOCUMENT SOUPLE**  
20 pochettes 40 vues A4  
Couleurs panachées :  
incolore, bleu, rouge et vert



**V387**  
**PERSONNALISABLE**  
**PROTÈGE DOCUMENT SOUPLE**  
40 pochettes 80 vues A4  
Couleurs au choix :  
incolore, bleu, rouge ou vert



**V388**  
**PERSONNALISABLE**  
**PROTÈGE DOCUMENT SOUPLE**  
40 pochettes 80 vues A4  
Couleurs panachées :  
incolore, bleu, rouge et vert



Photographies non contractuelles  
Reproduction interdite. © APEI 2024

# GAMME PAPETERIE



CADRE MAGNÉTIQUE DURABLE



A4

V276/V276 0

**POCHETTE ADHÉSIVE  
REPOSITIONNABLE**  
Format A4

CADRE MAGNÉTIQUE DURABLE



A5

V276 5

**POCHETTE ADHÉSIVE  
REPOSITIONNABLE**  
Format A5

CADRE MAGNÉTIQUE DURABLE



A3

V276 3

**POCHETTE ADHÉSIVE  
REPOSITIONNABLE**  
Format A3



A3

A4

A5

V277

**POCHETTE ADHÉSIVE  
REPOSITIONNABLE**  
Panaché : 1 format A3  
+ 2 formats A4 + 2 formats A5



A4

V282

**POCHETTE ADHÉSIVE  
REPOSITIONNABLE**  
Format A4



V275

**POCHETTE ADHÉSIVE TRANSPARENTE  
POUR AFFICHAGE MURAL**  
Pour documents A4. Ouverture côté  
droit pour présentation verticale



A4

V280

**POCHETTE VITRO STATIQUE  
REPOSITIONNABLE**  
Cadre magnétique "DURABLE"  
Format A4



A3

V280 3

**POCHETTE VITRO STATIQUE  
REPOSITIONNABLE**  
Cadre magnétique "DURABLE"  
Format A3

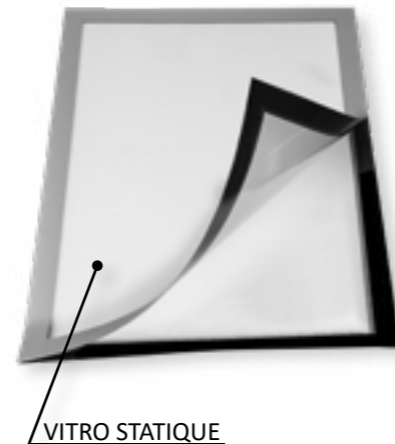

VITRO STATIQUE



Photographies non contractuelles  
Reproduction interdite. © APEI 2024

# GAMME PAPETERIE



V480

**RAMETTE PAPIER A4  
BLANC**  
500 feuilles - 80 g/m<sup>2</sup>



V482/V482 1

**RAMETTE PAPIER A3  
BLANC**  
500 feuilles - 80 g/m<sup>2</sup>



V485

**RAMETTE PAPIER A4  
BLEU**  
500 feuilles - 80 g/m<sup>2</sup>



V486

**RAMETTE PAPIER A4  
JAUNE**  
500 feuilles - 80 g/m<sup>2</sup>



V487

**RAMETTE PAPIER A4  
ROSE**  
500 feuilles - 80 g/m<sup>2</sup>



V488

**RAMETTE PAPIER A4  
VERT**  
500 feuilles - 80 g/m<sup>2</sup>



V489

**RAMETTE PAPIER A4  
PANACHÉES**  
Bleu, jaune, rose et vert  
500 feuilles - 80 g/m<sup>2</sup>



V478

**RAMETTE PAPIER A4  
BLANCHEUR 95 CIE**  
500 feuilles - 80 g/m<sup>2</sup>  
100% recyclé



V479

**RAMETTE PAPIER A4  
BLANCHEUR 135 CIE**  
500 feuilles - 80 g/m<sup>2</sup>  
100% recyclé



V496

**RAMETTE PAPIER A4  
BLANC** 500 feuilles  
100 g/m<sup>2</sup> photocopieurs et  
imprimantes laser couleur



V499

**RAMETTE PAPIER A4  
BLANC** 500 feuilles  
90 g/m<sup>2</sup> photocopieurs et  
imprimantes jet d'encre



V476

**FEUILLE INDÉCHIRABLE A4**



Photographies non contractuelles  
Reproduction interdite. © APEI 2024

# GAMME PAPETERIE



V620

**STYLO BILLE**  
Corps transparent  
Couleurs au choix : bleu, noir, rouge ou vert



V621

**STYLO BILLE**  
8 noirs, 8 bleus, 2 rouges et 2 verts  
Corps transparent



V611

**STYLO BILLE**  
Pointe moyenne 1,6 mm  
Corps transparent  
Turquoise



V633

**STYLO FEUTRE NYLON**  
Pointe moyenne souple large 0,8 mm  
Couleurs au choix : bleu, rouge ou noir



V625

**STYLO BILLE RÉTRACTABLE**  
4 COULEURS Rechargeable  
Noir, rouge, vert et bleu



V637

**STYLO BILLE RÉTRACTABLE**  
4 COULEURS Surligneur jaune fluo  
Rechargeable en noir, rouge et bleu



V628

**STYLO BILLE "M10" RÉTRACTABLE**  
À la couleur : noir, bleu ou rouge  
Par boîte de 6



V630

**STYLO BILLE "M10" RÉTRACTABLE**  
À la couleur : noir, bleu ou rouge  
Par boîte de 20



V629

**STYLO BILLE "M10" RÉTRACTABLE**  
Couleurs panachées :  
3 noirs, 2 bleus et 1 rouge



V638

**STYLO BILLE RÉTRACTABLE**  
4 COULEURS - MINE Rechargeable  
bleu, noir et rouge (V624)  
Mine 0,7 mm (V616 7)



V640

**STYLO BILLE RÉTRACTABLE**  
4 COULEURS  
Rechargeable (V624)  
Effet bois



V641

**STYLO BILLE RÉTRACTABLE**  
4 COULEURS  
Rechargeable (V624)  
Effet drapeau français



V631

**STYLO BILLE "M10" RÉTRACTABLE**  
Couleurs panachées :  
8 noirs, 8 bleus et 4 rouges



V626

**STYLO GEL RÉTRACTABLE**  
GRIP CAOUTCHOUC  
Pointe moyenne 0,7 mm  
Bleu, noir ou rouge



V627

**STYLO GEL RÉTRACTABLE**  
GRIP CAOUTCHOUC  
Couleurs panachées :  
2 bleus, 2 noirs et 2 rouges



V632

**STYLO BILLE RÉTRACTABLE**  
4 recharges bleu  
Socle lesté noir  
Grande capacité d'écriture



V737

**STYLO BILLE SUR SOCLE**  
LESTÉ  
Encre noire



V737 9

**RECHARGE POUR STYLO**  
BILLE SUR SOCLE LESTÉ  
Encre noire



V624

**RECHARGE STYLO**  
4 COULEURS. Au choix :  
bleu, noir, rouge ou vert  
Pour stylos V625, V632, V637,  
V638 et V640

# GAMME PAPETERIE



**V613**  
**CRAYON PAPIER HB HAUTE QUALITÉ**  
 Mine graphite



**V614**  
**CRAYON PAPIER**  
 Mine graphite



**V615**  
**PORTE-MINE JETABLE AVEC GOMME**  
 Mine 0,7 mm



**V616**  
**RECHARGE POUR PORTE-MINE**  
 Mine 0,5 mm



**V616 7**  
**RECHARGE POUR PORTE-MINE**  
 Mine 0,7 mm



**V617**  
**PORTE-MINES RECHARGEABLE**  
**GRIP CAOUTCHOUC**  
 Mine 0,7 mm  
 Gomme avec protecteur



# GAMME PAPETERIE



**V562**  
**DÉROULEUR DE CORRECTION**  
 5 mm x 8 mm



**V566**  
**DÉROULEUR DE COLLE PERMANENTE**  
 8 mm x 12 mm



**V565**  
**BÂTON DE COLLE**



**V585**  
**BRACELET ÉLASTIQUE ÉTROT**  
 125 mm



**V586**  
**BRACELET ÉLASTIQUE LARGE**  
 120 mm



**V590**  
**GOMME PLASTIQUE**  
 Sous fourreau pour crayon



**V723**  
**ÉPINGLE DE FIXATION**  
 Couleurs panachées

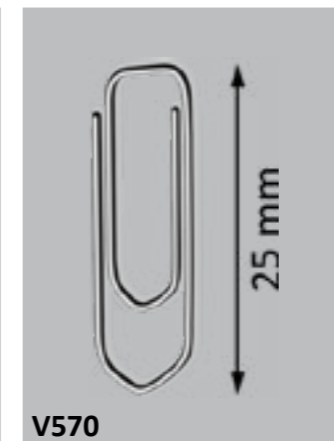

**V570**  
**TROMBONE FORME CHEVRON**  
 Acier galvanisé

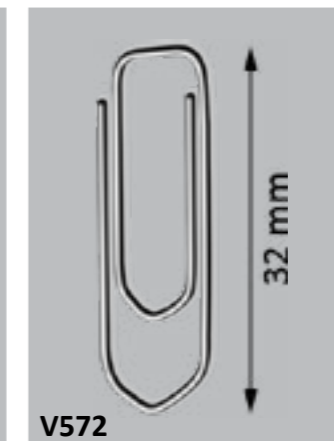

**V572**  
**TROMBONE FORME CHEVRON**  
 Acier galvanisé

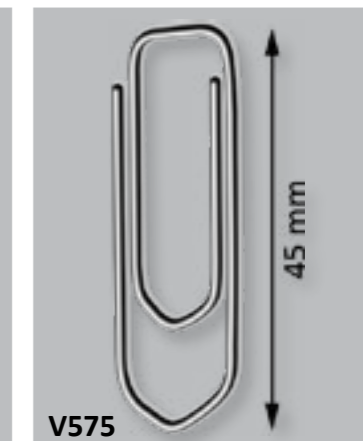

**V575**  
**TROMBONE FORME CHEVRON**  
 Acier galvanisé

# GAMME PAPETERIE



V652

## SURLIGNEURS VERT

Épaisseur du trait : 1-5 mm  
Pointe biseautée



V653

## SURLIGNEURS ROSE

Épaisseur du trait : 1-5 mm  
Pointe biseautée



V654

## SURLIGNEURS ORANGE

Épaisseur du trait : 1-5 mm  
Pointe biseautée



V656

## SURLIGNEURS

8 couleurs panachées : 2 jaunes/2 verts/1 bleu/1 rose  
1 orange/1 lavande/1 lilas/1 turquoise



V663

## MARQUEUR CRAIE

Couleurs panachées : blanc/jaune/rose/  
bleu. Ecriture sur fenêtres, vitrines,  
ardoises, tableaux noirs, vitres de voitures



V664

## MARQUEUR CRAIE

Couleurs au choix : blanc/jaune/rose/  
bleu. Ecriture sur fenêtres, vitrines,  
ardoises, tableaux noirs, vitres de voitures



# GAMME PAPETERIE

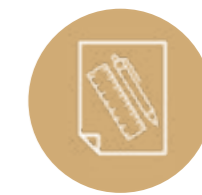

V657

## MARQUEUR PERMANENT

Pour paper board  
Couleurs panachées :  
bleu, rouge, vert et noir



V659

## MARQUEUR PERMANENT

Pour paper board  
Couleurs au choix :  
bleu, rouge, vert ou noir



V658

## MARQUEUR EFFAÇABLE À SEC

Pour tableau blanc  
Couleurs panachées :  
bleu, rouge, vert et noir



V660

## MARQUEUR EFFAÇABLE À SEC

Pour tableau blanc  
Couleurs au choix :  
bleu, rouge, vert ou noir



V645

## SURLIGNEURS LAVANDE

Épaisseur du trait : 1-5 mm  
Pointe biseautée



V646

## SURLIGNEURS LILAS

Épaisseur du trait : 1-5 mm  
Pointe biseautée



V647

## SURLIGNEURS TURQUOISE

Épaisseur du trait : 1-5 mm  
Pointe biseautée



V650

## SURLIGNEURS JAUNE

Épaisseur du trait : 1-5 mm  
Pointe biseautée



V651

## SURLIGNEURS BLEU

Épaisseur du trait : 1-5 mm  
Pointe biseautée



# GAMME PAPETERIE



V090

**RECHARGE DE PAPIER BLANC**  
Pour chevalet de conférence  
Rouleau de 50 feuilles  
Recyclable



V672

**BROSSE EFFACEUR MAGNÉTIQUE**  
Pour tableaux blancs. Support  
polystyrène et feutre pure laine



V670

**KIT POUR TABLEAU BLANC**  
1 brosse effaceur magnétique  
4 marqueurs effaçables à sec  
5 aimants



V578

**AIMANT "MAGNET" Ø 22 MM**  
Couleurs panachées :  
bleu, rouge, vert, blanc et noir



V579

**AIMANT "MAGNET" Ø 22 MM**  
Couleurs au choix :  
bleu, rouge, vert, blanc ou noir



V735

**PORTE-CLÉS "ÉTIQUETTES"**  
En plastique. Couleurs panachées :  
5 bleus, 5 rouges, 5 verts, 5 jaunes et 5  
noirs



# GAMME PAPETERIE

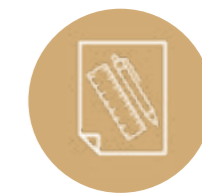

V719

**PINCE AGRAFEUSE**  
Indicateur point rouge de niveau de  
stock agrafes. Ôte-agrafes sur poignée.  
Agrafes n°10



V721

**PINCE AGRAFEUSE**  
Indicateur point rouge de niveau de  
stock agrafes. Ôte-agrafes sur poignée.  
Agrafes n°24/6 ou 26/6 et 24/8 ou 26/8



F210

**AGRAFEUSE DE BUREAU**  
Capacité 20 feuilles 80 g/m<sup>2</sup>  
Agrafes : 26/6 ou 24/6



F214

**ÔTE-AGRAFES**  
Plastique ABS et acier finition  
chrome.



V720

**AGRAFES N°10**



V722 4

**AGRAFES N° 24/6 STANDARD**



V722 8

**AGRAFES N° 26/8 STANDARD**



F216

**PERFORATEUR DE BUREAU 2 TROUS**  
En métal noir



F208

**PINCE DOUBLE CLIP**  
41 mm

# GAMME PAPETERIE



**V708**  
**CUTTER**  
Avec recharge de 10 lames  
Lames de rechange V709



**V709**  
**LAMES DE RECHANGE**  
Pour cutter V708



**V710**  
**COUTEAU DE SÉCURITÉ**  
À lame auto-rétractable (cutter)  
Ergonomique - Ambidextre



**V712**  
**COUTEAU DE DÉBALLAGE**  
Coupe les sangles, bandes adhésives,  
film plastique, ...



**V713**  
**LAMES DE RECHANGE**  
Pour couteau de déballage V712



**V711**  
**LAMES DE RECHANGE**  
Pour couteau de sécurité V710



**V718**  
**CISEAUX DE BUREAU**  
Poignée noire  
Lames et rivet en acier inoxydable



# GAMME PAPETERIE



# GAMME CLASSEMENT



Le Verdier



Le Verdier



Le Verdier



Le Verdier



Photographies non contractuelles  
Reproduction interdite. © APEI 2024

# GAMME CLASSEMENT



**V130**  
**BOÎTE ARCHIVE IMPRIMÉE BLEU.** 34 x 25 cm  
Dos 10 cm. Carton fort  
Montage automatique



**V131**  
**BOÎTE ARCHIVE IMPRIMÉE JAUNE.** 34 x 25 cm  
Dos 10 cm. Carton fort  
Montage automatique



**V132**  
**BOÎTE ARCHIVE IMPRIMÉE ROUGE.** 34 x 25 cm  
Dos 10 cm. Carton fort  
Montage automatique



**V133**  
**BOÎTE ARCHIVE IMPRIMÉE VERT.** 34 x 25 cm  
Dos 10 cm. Carton fort  
Montage automatique



**V134**  
**BOÎTE ARCHIVE IMPRIMÉE ORANGE.** 34 x 25 cm  
Dos 10 cm. Carton fort  
Montage automatique



**V135**  
**BOÎTE ARCHIVE IMPRIMÉE PANACHÉE.** 34 x 25 cm  
Dos 10 cm. Carton fort  
Montage automatique



**V120**  
**BOÎTE ARCHIVE IMPRIMÉE NOIR.** 34 x 25 cm  
Dos 10 cm. Carton fort  
Montage automatique



**V140**  
**BOÎTE ARCHIVE IMPRIMÉE NOIR.** 34 x 25 cm  
Dos 15 cm. Carton fort  
Montage automatique



**V141**  
**BOÎTE ARCHIVE IMPRIMÉE NOIR.** 34 x 25 cm  
Dos 20 cm. Carton fort  
Montage automatique



**V150**  
**CAISSE ARCHIVE IMPRIMÉE**  
53 x 27 x 35 cm  
Carton extra fort  
Montage semi-automatique



**V175**  
**CLASSEUR ARCHIVE**  
Dos de 5 cm. Dimensions à plat : 557 x 320 mm  
Avec rainage et perforation



**V583**  
**CLIP RELIEUR D'ARCHIVES**  
Plastique  
Ecartement 80 mm



Photographies non contractuelles  
Reproduction interdite. © APEI 2024

# GAMME CLASSEMENT



**V110**  
**BOÎTE ARCHIVE IMPRIMÉE BLEU**  
 34 x 25 mm. Dos de 8 cm  
 Carton fort. Montage manuel



**V111**  
**BOÎTE ARCHIVE IMPRIMÉE JAUNE**  
 34 x 25 mm. Dos de 8 cm  
 Carton fort. Montage manuel



**V112**  
**BOÎTE ARCHIVE IMPRIMÉE ROUGE**  
 34 x 25 mm. Dos de 8 cm  
 Carton fort. Montage manuel



**V113**  
**BOÎTE ARCHIVE IMPRIMÉE VERT**  
 34 x 25 mm. Dos de 8 cm  
 Carton fort. Montage manuel



**V114**  
**BOÎTE ARCHIVE IMPRIMÉE ORANGE**  
 34 x 25 mm. Dos de 8 cm  
 Carton fort. Montage manuel



**V115**  
**BOÎTE ARCHIVE IMPRIMÉE PANACHÉE**  
 34 x 25 mm. Dos de 8 cm. Carton fort.  
 Montage manuel. 5 couleurs : bleu,  
 jaune, rouge, vert et orange



**V170**  
**BOÎTE ARCHIVE À TIROIR**  
 Dim. boîte extérieure 36,5 x 28 x 9 cm  
 Hauteur tiroir : 7,8 cm.  
 Carton. Montage manuel



**V172**  
**BOÎTE ARCHIVE À TIROIR**  
 Dim. boîte extérieure 36,5 x 28 x 14 cm  
 Hauteur tiroir : 12 cm.  
 Carton. Montage manuel



# GAMME CLASSEMENT

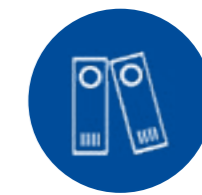

**V165**  
**BOÎTE DE CLASSEMENT À PAN COUPÉ**  
 32,5 x 24 cm. 4 couleurs au choix :  
 bleu, rouge, vert ou jaune. Carton fort  
 Montage automatique. Dos de 10 cm



**V166**  
**BOÎTE DE CLASSEMENT À PAN COUPÉ**  
 32,5 x 24 cm. 4 couleurs panachées :  
 bleu, rouge, vert et jaune. Carton fort  
 Montage automatique. Dos de 10 cm



**V167**  
**BOÎTE DE TRANSFERT**  
 34 x 25,5 cm. 4 couleurs au choix :  
 bleu, rouge, vert ou jaune. Carton fort  
 Montage manuel. Dos de 9 cm



**V168**  
**BOÎTE DE TRANSFERT**  
 34 x 25,5 cm. 4 couleurs panachées :  
 bleu, rouge, vert et jaune. Carton fort  
 Montage manuel. Dos de 9 cm



**V145**  
**BOÎTE ARCHIVE**  
 34 x 25 cm. Carton kraft  
 Cannelure apparente. Dos de 10 cm



# GAMME CLASSEMENT



**V400/V420**  
**CLASSEUR PLASTIFIÉ BLEU**  
À levier rapporté en inox  
V400 = dos de 7 cm  
V420 = dos de 5 cm



**V401/V421**  
**CLASSEUR PLASTIFIÉ ROUGE**  
À levier rapporté en inox  
V401 = dos de 7 cm  
V421 = dos de 5 cm



**V402/V422**  
**CLASSEUR PLASTIFIÉ ORANGE**  
À levier rapporté en inox  
V402 = dos de 7 cm  
V422 = dos de 5 cm



**V403/V423**  
**CLASSEUR PLASTIFIÉ VERT**  
À levier rapporté en inox  
V403 = dos de 7 cm  
V423 = dos de 5 cm



**V404/V424**  
**CLASSEUR PLASTIFIÉ JAUNE**  
À levier rapporté en inox  
V404 = dos de 7 cm  
V424 = dos de 5 cm



**V405/V425**  
**CLASSEUR PLASTIFIÉ BLANC**  
À levier rapporté en inox  
V405 = dos de 7 cm  
V425 = dos de 5 cm



**V406/V426**  
**CLASSEUR PLASTIFIÉ NOIR**  
À levier rapporté en inox  
V406 = dos de 7 cm  
V426 = dos de 5 cm



**V407**  
**CLASSEUR PLASTIFIÉ VIOLINE**  
À levier rapporté en inox  
Dos de 7 cm



**V408**  
**CLASSEUR PLASTIFIÉ VERT ANIS**  
À levier rapporté en inox  
Dos de 7 cm



**V409**  
**CLASSEUR PLASTIFIÉ FRAMBOISE**  
À levier rapporté en inox  
Dos de 7 cm



**V411**  
**CLASSEUR PLASTIFIÉ PANACHÉ**  
À levier rapporté en inox  
Dos de 7 cm



**V431**  
**CLASSEUR PLASTIFIÉ PANACHÉ**  
À levier rapporté en inox  
Dos de 5 cm



Photographies non contractuelles  
Reproduction interdite. © APEI 2024

# GAMME CLASSEMENT



**V448**  
**INTERCALAIRES "A4+" 6 TOUCHES**  
Polypropylène 0,30 mm



**V449**  
**INTERCALAIRES "A4+" 12 TOUCHES**  
Polypropylène 0,20 mm

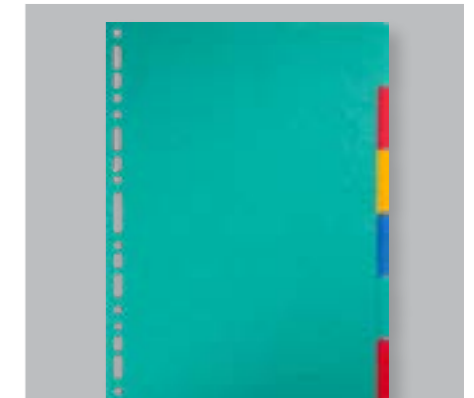

**V450**  
**INTERCALAIRES 6 TOUCHES**  
6 couleurs  
Carte lustrée

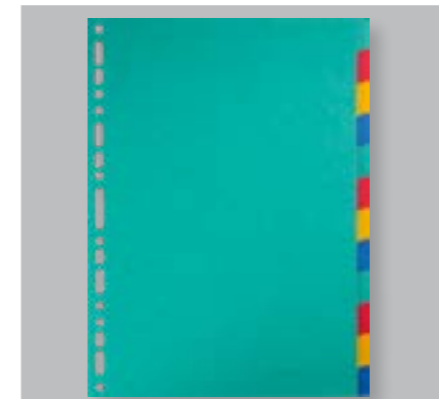

**V451**  
**INTERCALAIRES 12 TOUCHES**  
12 couleurs  
Carte lustrée



**V452**  
**INTERCALAIRES A À Z**  
18 touches  
Carte peau d'âne

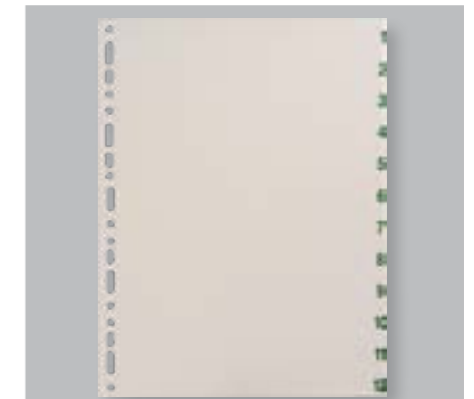

**V453**  
**INTERCALAIRES 1 À 12**  
12 touches  
Carte peau d'âne



**V454**  
**INTERCALAIRES JANVIER À DÉCEMBRE**  
12 touches  
Carte peau d'âne

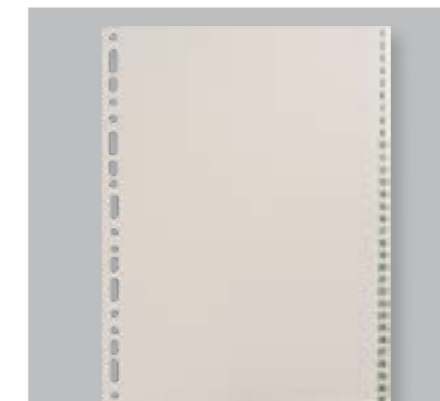

**V455**  
**INTERCALAIRES 1 À 31**  
31 touches  
Carte peau d'âne



**V410**  
**CLASSEUR CARTON GRIS**  
À levier rapporté en inox  
Dos de 7 cm



Photographies non contractuelles  
Reproduction interdite. © APEI 2024

# GAMME CLASSEMENT



**V443**  
**CHEMISE DE CLASSEMENT**  
 A4 perforées à 4 trous  
 250 g/m<sup>2</sup>. 6 couleurs panachées



**V446**  
**ENVELOPPE DE CLASSEMENT**  
 A4 perforée 11 trous. Translucide  
 80% polypropylène recyclé.  
 6 couleurs panachées



**V447**  
**ENVELOPPE DE CLASSEMENT**  
 A4 perforée 11 trous. Translucide  
 80% polypropylène recyclé.  
 6 enveloppes incolores



**V470**  
**POCHETTE TRANSPARENTE**  
**11 TROUS**  
 Pour format A4  
 Polypropylène 7,5/100



**V471**  
**POCHETTE TRANSPARENTE**  
**11 TROUS**  
 Pour format A4  
 Polypropylène 9/100



**V472**  
**POCHETTE TRANSPARENTE**  
**11 TROUS OUVERTURE GAUCHE**  
 Pour format A4. Aspect grainé  
 Polypropylène 8,5/100



Photographies non contractuelles  
 Reproduction interdite. © APEI 2024

# GAMME CLASSEMENT



**V260**  
**CHEMISE À ÉLASTIQUE 3 RABATS**  
 4 couleurs panachées :  
 bleu, rouge, vert et noir  
 Polypropylène 8/10



**V261**  
**CHEMISE À ÉLASTIQUE 3 RABATS**  
 Bleu  
 Polypropylène 8/10



**V263**  
**CHEMISE À ÉLASTIQUE 3 RABATS**  
 Vert  
 Polypropylène 8/10



**V264**  
**CHEMISE À ÉLASTIQUE 3 RABATS**  
 Noir  
 Polypropylène 8/10



**V278**  
**CHEMISE À ÉLASTIQUE 3 RABATS**  
 4 couleurs panachées :  
 bleu, rouge vert et jaune  
 Polypropylène 8/10



**V279**  
**CHEMISE À ÉLASTIQUE 3 RABATS**  
 4 couleurs au choix :  
 bleu, rouge vert ou jaune  
 Polypropylène 8/10



**V155**  
**BOÎTE ARCHIVE**  
 4 couleurs au choix :  
 bleu, rouge vert ou jaune  
 Polypropylène 8/10



**V156**  
**BOÎTE ARCHIVE**  
 4 couleurs panachées :  
 bleu, rouge vert et jaune  
 Polypropylène 8/10



Photographies non contractuelles  
 Reproduction interdite. © APEI 2024

# GAMME CLASSEMENT



**V200 à V209**  
**CHEMISES À LA COULEUR**  
210g  
24 x 32 cm



**V210**  
**CHEMISES COULEURS PANACHÉES**  
210g  
24 x 32 cm



**V220 à V229**  
**SOUS-CHEMISES À LA COULEUR**  
80g  
22 x 31 cm



**V230**  
**SOUS-CHEMISES COULEURS PANACHÉES**  
80g  
22 x 31 cm



**V296**  
**40 COUVERTURES A4**  
Pour relier par anneaux. Carton fort  
Aspect grain de cuir  
8 couleurs panachées



**V298**  
**25 COUVERTURES A4**  
Pour relier par anneaux. Carton fort  
Aspect grain de cuir  
Coloris au choix



**V298**  
**PEIGNE À RELIER PLASTIQUE**  
PVC noir  
25 peignes en 6 mm  
25 peignes en 10 mm



**V299**  
**COUVERTURE A4 PVC TRANSPARENT**  
Pour relier par anneaux

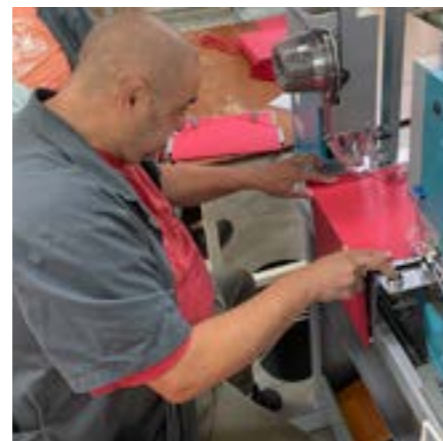

# GAMME CLASSEMENT

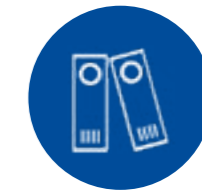

**V267**  
**CHEMISE COINS A4 À FENÊTRE (10x18)**. Couleurs au choix : bleu, rouge, vert, jaune ou orange  
Ouverture 2 côtés



**V268**  
**CHEMISE COINS A4 À FENÊTRE (10x18)**. Couleurs panachées : bleu, rouge, vert, jaune et orange  
Ouverture 2 côtés



**V269**  
**CHEMISE COINS A4**  
Ouverture 2 côtés. Polypropylène 100% recyclé. Transparent. Épaisseur : 12/100e  
22 x 31 cm



**V270**  
**CHEMISE COINS A4**  
Ouverture 2 côtés. PVC transparent  
Épaisseur : 20/100e

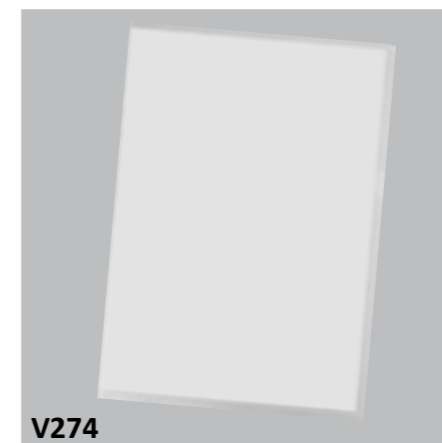

**V274**  
**CHEMISE COINS A4**  
Ouverture 2 côtés. PVC transparent  
Épaisseur : 13/100e

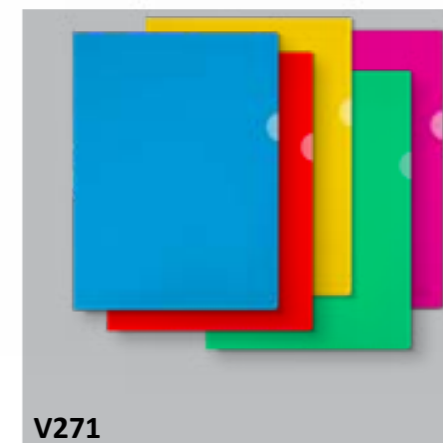

**V271**  
**CHEMISE COINS A4**  
5 couleurs panachées ou à la couleur : bleu, rouge vert, jaune et violet  
Épaisseur : 13/100e



**V233**  
**TRIEUR À ÉLASTIQUE 12 POSITIONS**  
Orange  
Carte lustrée 5/10e



# GAMME CLASSEMENT



V211

**CHEMISE DOS TOILÉ**  
320g. 24x32 cm. Dos de 3 cm. Carte forte 100% recyclée. 4 couleurs au choix : bleu, rouge, vert ou jaune



V212

**CHEMISE DOS TOILÉ**  
320g. 24x32 cm. Dos de 3 cm. Carte forte 100% recyclée. 4 couleurs panachées : bleu, rouge, vert ou jaune



V213

**CHEMISE DOS TOILÉ PERSONNALISABLE.** Carte forte 100% recyclée. 4 couleurs au choix : bleu, rouge, vert ou jaune



V214

**CHEMISE DOS TOILÉ PERSONNALISABLE.** Carte forte 100% recyclée. 4 couleurs panachées : bleu, rouge, vert et jaune



V215

**CHEMISE DOS TOILÉ**  
Carte lustrée. 4 couleurs au choix : bleu, rouge, vert ou jaune



V216

**CHEMISE DOS TOILÉ**  
Carte lustrée. 4 couleurs panachées : bleu, rouge, vert et jaune

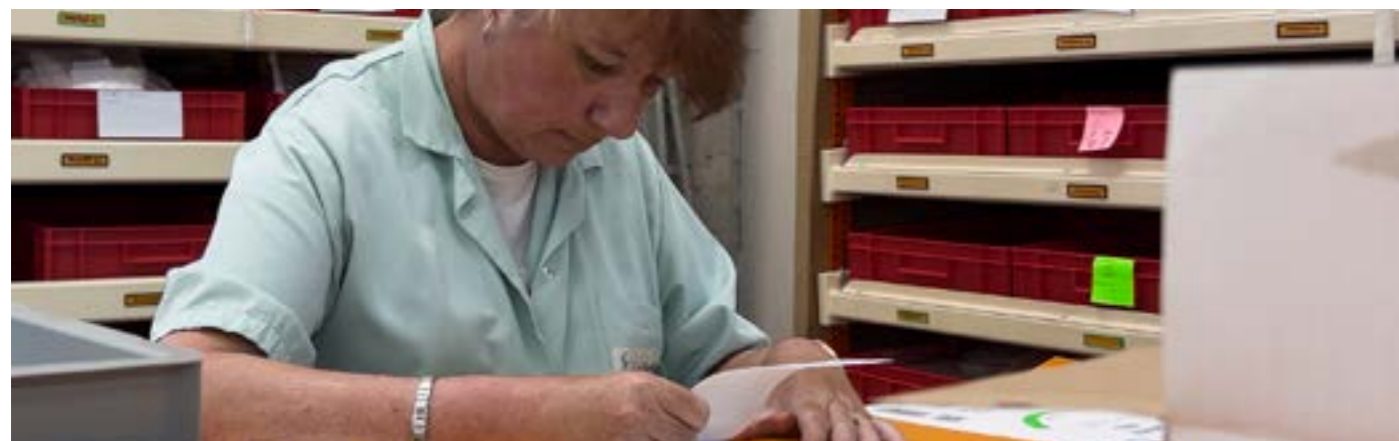

# GAMME CLASSEMENT



V265

**CHEMISE POCHETTE AVEC SOUFFLETS 28 mm**  
5 couleurs au choix : bleu, rouge, vert, jaune ou orange



V266

**CHEMISE POCHETTE AVEC SOUFFLETS 28 mm**  
5 couleurs panachées : bleu, rouge, vert, jaune et orange



V273

**CHEMISE 2 RABATS**  
5 couleurs panachées : bleu, rose, vert, jaune et bulle

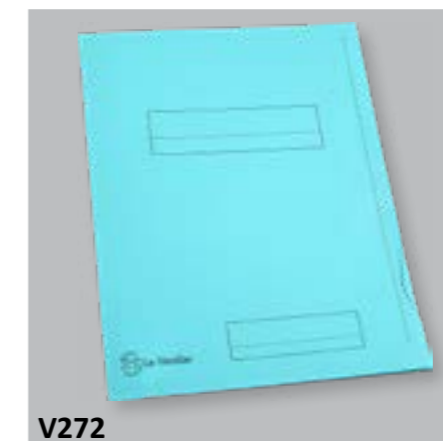

V272

**CHEMISE 2 RABATS**  
5 couleurs panachées : bleu, rose, vert, jaune ou bulle



V238

**CHEMISE 2 RABATS PERSONNALISABLE**  
Carte lustrée. 4 couleurs au choix : bleu, rouge, vert ou jaune



V239

**CHEMISE 2 RABATS PERSONNALISABLE**  
Carte lustrée. 4 couleurs panachées : bleu, rouge, vert et jaune





# GAMME CLASSEMENT



**V246**  
**CHEMISE EXTENSIBLE 10 CM**  
 Couleurs panachées : bleu, rouge, vert, jaune et orange. Fermeture velcro avec grand rabat. Carton recouvert de textile



**V247**  
**CHEMISE EXTENSIBLE 10 CM**  
 Couleurs panachées : bleu, rouge, vert, jaune et orange. Fermeture velcro avec grand rabat. Carton recouvert de textile



**V248**  
**CHEMISE EXTENSIBLE 10 CM**  
 Fermeture velcro avec grand rabat. Carton kraft



**V250**  
**CHEMISE EXTENSIBLE 10 CM**  
 À sangle. Carton kraft



**V251**  
**CHEMISE EXTENSIBLE 10 CM**  
 Bleu. À sangle. Carton recouvert de textile



**V252**  
**CHEMISE EXTENSIBLE 10 CM**  
 Rouge. À sangle. Carton recouvert de textile



**V253**  
**CHEMISE EXTENSIBLE 10 CM**  
 Vert. À sangle. Carton recouvert de textile



**V254**  
**CHEMISE EXTENSIBLE 10 CM**  
 Jaune. À sangle. Carton recouvert de textile



**V255**  
**CHEMISE EXTENSIBLE 10 CM**  
 Orange. À sangle. Carton recouvert de textile



Photographies non contractuelles  
 Reproduction interdite. © APEI 2024

# GAMME CLASSEMENT



**V259**  
**CHEMISE EXTENSIBLE 10 CM**  
 Couleurs panachées : bleu, rouge, vert, jaune et orange. À sangle. Carton recouvert de textile



**V258**  
**CHEMISE EXTENSIBLE 10 CM**  
 Fermeture velcro. Carton kraft



**V256**  
**CHEMISE EXTENSIBLE 10 CM**  
 Couleurs au choix : bleu, rouge, vert, jaune ou orange. Fermeture velcro. Carton recouvert de textile



**V257**  
**CHEMISE EXTENSIBLE 10 CM**  
 Couleurs panachées : bleu, rouge, vert, jaune et orange. Fermeture velcro. Carton recouvert de textile



Photographies non contractuelles  
 Reproduction interdite. © APEI 2024

# GAMME CLASSEMENT

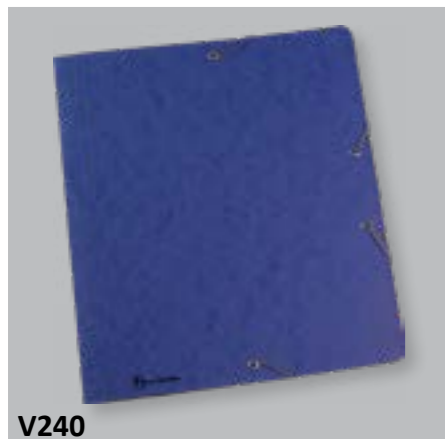

**V240**  
CHEMISE À ELASTIQUE 3 RABATS  
Bleu  
Carte lustrée

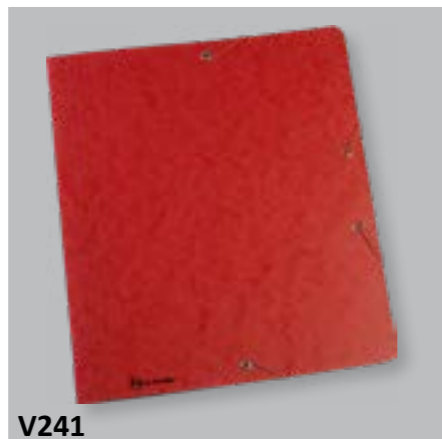

**V241**  
CHEMISE À ELASTIQUE 3 RABATS  
Rouge  
Carte lustrée



**V242**  
CHEMISE À ELASTIQUE 3 RABATS  
Vert  
Carte lustrée



**V243**  
CHEMISE À ELASTIQUE 3 RABATS  
Jaune  
Carte lustrée



**V249**  
CHEMISE À ELASTIQUE 3 RABATS  
4 couleurs panachées :  
bleu, rouge, vert et jaune

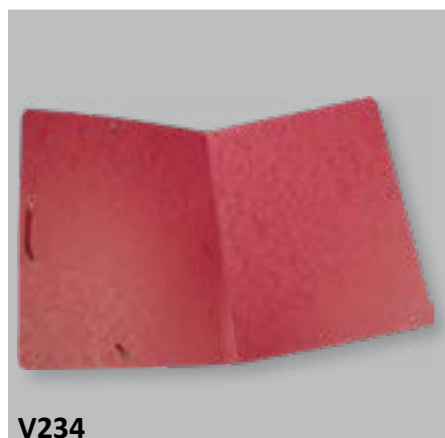

**V234**  
CHEMISE À ELASTIQUE SANS  
RABAT Carte lustrée 5/10e  
4 couleurs au choix :  
bleu, rouge, vert ou jaune



**V235**  
CHEMISE À ELASTIQUE SANS  
RABAT Carte lustrée 5/10e  
4 couleurs panachées :  
bleu, rouge, vert et jaune



# GAMME CLASSEMENT

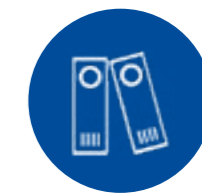

**V312**  
DOSSIER SUSPENDU TIROIR KRAFT  
24,5 x 34,8 cm. Fond de 15 mm  
Assemblage par pression  
Avec 25 bandes de lecture



**V313**  
DOSSIER SUSPENDU ARMOIRE KRAFT  
24,5 x 34,8 cm. Fond de 15 mm  
Assemblage par pression  
Avec 25 bandes de lecture



**V317**  
DOSSIER SUSPENDU TIROIR KRAFT  
24,5 x 34,8 cm. Fond de 30 mm  
Assemblage par pression  
Avec 25 bandes de lecture



**V318**  
DOSSIER SUSPENDU ARMOIRE KRAFT  
24,5 x 34,8 cm. Fond de 30 mm  
Assemblage par pression  
Avec 25 bandes de lecture

# GAMME COLIS



 Le Verdier

 L'Artisanerie



 Le Verdier

 Apei  
FARMACIA  
MUNDOCHI

# GAMME COLIS



V100

COLIS PAPETERIE



A001

COLIS ARTI'NET

 Apei  
FARMACIA  
MUNDOCHI

# GAMME COLIS



A003  
COLIS AIRFLOR DÉSODORISANT

# GAMME COLIS



V900  
COLIS PARAPHARMACIE



A002  
COLIS NETTOYAGE MICROFIBRE



# GAMME COLIS



A004

COLIS ACTION L'Artisanerie



V102

COLIS ACTION Le Verdier

# GAMME COLIS





L'APEI de Saint-Amand-Montrond,  
**un état d'esprit**